

Panasonic

Compact Plain Paper FAX

Model No.

KX-FP250

KX-FP245

Quick Start



To get started,
please read the
Quick Start section
(pages 4 to 11).

OPERATING INSTRUCTIONS



Please read these Operating Instructions before using the unit and save for future reference.

FOR OPERATION ASSISTANCE,
CALL 1-800-HELP-FAX (1-800-435-7329)
OR SEND A FAX TO 1-215-741-6376.

- This unit is designed for use in the United States of America, and may not operate in other countries. (See page 97 for more details.)
- Este producto ha sido diseñado para su uso en los Estados Unidos de América, y puede no funcionar correctamente en otros países. (Consulte la página 97 para tener más detalles.)

Comienzo Rápido (p. 98)

Initial Preparation

Telephone

Fax/Copy

Help

General Information

Comienzo rápido en español (p. 98)

Thank you for purchasing a Panasonic facsimile.

Welcome to the world of Panasonic facsimiles.

This product combines the facsimile, telephone and copier features to provide you with more efficient office or home use. By utilizing these convenient features, you can maximize the effectiveness of this unit.

Things you should keep record of

Attach your sales receipt here

For your future reference

Date of purchase

Serial number

(found on the bottom of the unit)

Dealer's name and address

Dealer's telephone number

Caution:

- The Telephone Protection Act of 1991 requires the following information to be clearly stated either at the top or bottom margin of the first message page when transmitting messages via telephone facsimile;
 - Date and time of transmission,
 - Identification of the business, entity or person(s) sending the facsimile, and
 - Telephone number of the business, entity or person(s).To program this information into your unit, complete all the instructions on pages 25 through 28.
- Note that the images of copied or received documents will remain on the used film. When disposing of the used film, use discretion.
- Do not rub or use an eraser on the printed side, as the print may smear.
- If you have not applied to the *faxSAV*[®] service, you will not be able to use the IQ-FAX function (see pages 44 to 46).

Trademark

faxSAV is a registered trademark of FaxSav Incorporated.

Hammermill[®] is a registered trademark of INTERNATIONAL PAPER in the United States and/or other countries.

Copyright:

This manual is copyrighted by Kyushu Matsushita Electric Co., Ltd. (KME) and its licensee. Under the copyright laws, this manual may not be reproduced in any form, in whole or part, without the prior written consent of KME and its licensee.

© Kyushu Matsushita Electric Co., Ltd. 1998

Important safety instructions

When using this unit, basic safety precautions should always be followed to reduce the risk of fire, electric shock, or personal injury.

1. Read and understand all instructions.
2. Follow all warnings and instructions marked on this unit.
3. Unplug this unit from AC outlets before cleaning. Do not use liquid or aerosol cleaners. Use a damp cloth for cleaning.
4. Do not use this unit near water, for example near a bath tub, wash bowl, kitchen sink, or the like.
5. Place the unit securely on a stable surface. Serious damage and/or injury may result if the unit falls.
6. Do not cover slots and openings on the unit. They are provided for ventilation and protection against overheating. Never place the unit near radiators, or in a place where proper ventilation is not provided.
7. Use only the power source marked on the unit. If you are not sure of the type of power supplied to your home, consult your dealer or local power company.
8. For safety purposes this unit is equipped with a three prong grounded plug. If you do not have this type of outlet, please have one installed. Do not use any type of adaptor plug to defeat this safety feature.
9. Do not place objects on the power cord. Install the unit where no one can step or trip on the cord.
10. Do not overload wall outlets and extension cords. This can result in the risk of fire or electric shock.
11. Never push any objects through slots in this unit. This may result in the risk of fire or electric shock. Never spill any liquid on the unit.
12. To reduce the risk of electric shock, do not disassemble this unit. Take the unit to an authorized servicer when service is required. Opening or removing covers may expose you to dangerous voltages or other risks. Incorrect reassembly can cause electric shock when the unit is subsequently used.
13. Unplug this unit from the wall outlet and refer servicing to an authorized servicer when the following conditions occur:
 - A. When the power supply cord or plug is damaged or frayed.
 - B. If liquid has been spilled into the unit.
 - C. If the unit has been exposed to rain or water.
 - D. If the unit does not work normally by following the operating instructions. Adjust only controls covered by the operating instructions. Improper adjustment may require extensive work by an authorized servicer.
 - E. If the unit has been dropped or physically damaged.
 - F. If the unit exhibits a distinct change in performance.
14. During thunderstorms, avoid using telephones except cordless types. There may be a remote risk of an electric shock from lightning.
15. Do not use this unit to report a gas leak, when in the vicinity of the leak.

SAVE THESE INSTRUCTIONS

INSTALLATION:

1. Never install telephone wiring during a lightning storm.
2. Never install telephone jacks in wet locations unless the jack is specifically designed for wet locations.
3. Never touch uninsulated telephone wires or terminals unless the telephone line has been disconnected at the network interface.
4. Use caution when installing or modifying telephone lines.

WARNING:

- To prevent the risk of fire or electrical shock, do not expose this product to rain or any type of moisture.

OTHER INFORMATION

- Keep the unit away from electrical noise-generating devices, such as fluorescent lamps and motors.
- The unit should be kept free from dust, high temperature and vibration.
- The unit should not be exposed to direct sunlight.
- Do not place heavy objects on top of this unit.
- Do not touch the plug with wet hands.

Quick Start

Installation

Remove the shipping tape from the unit and stacker, and install as follows.

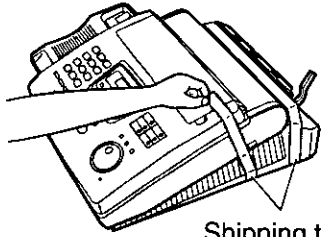

Shipping tape

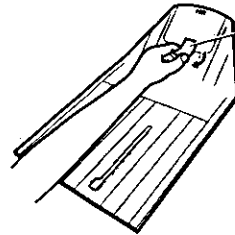

Shipping tape

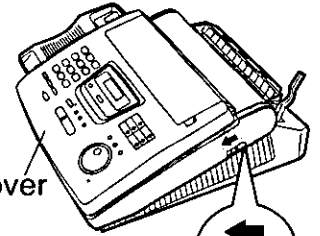

Cover

1

Film cartridge (See page 19.)

- A. Slide the cover open lever forward.
- B. The cover is under tension to improve print quality. Pull up hard enough to open.
- C. Remove the leaflet from the unit.
- D. If the film in the film cartridge is slack, tighten it by winding the bottom side gears.

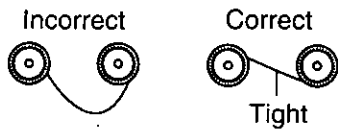

Incorrect

Correct

Tight

- E. Install the film cartridge into the unit.
- F. Make sure that the blue label on the cartridge matches the one on the unit.
- G. Close the cover securely by pushing down on both corners.

Cover open lever

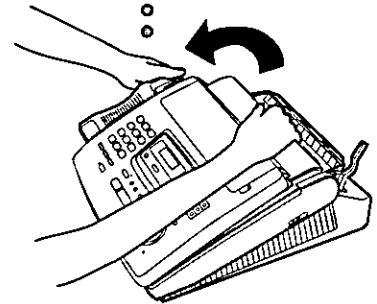

Blue label

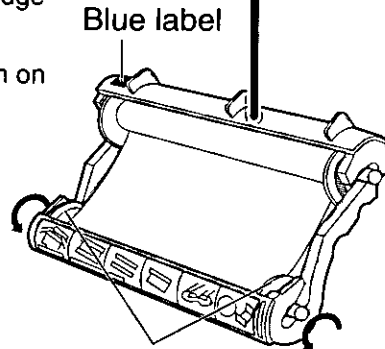

Bottom side gears

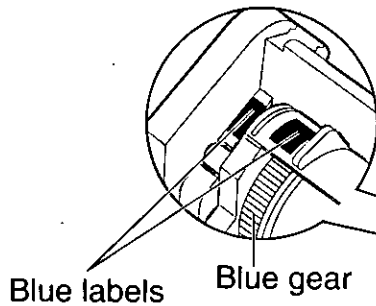

Blue labels

Blue gear

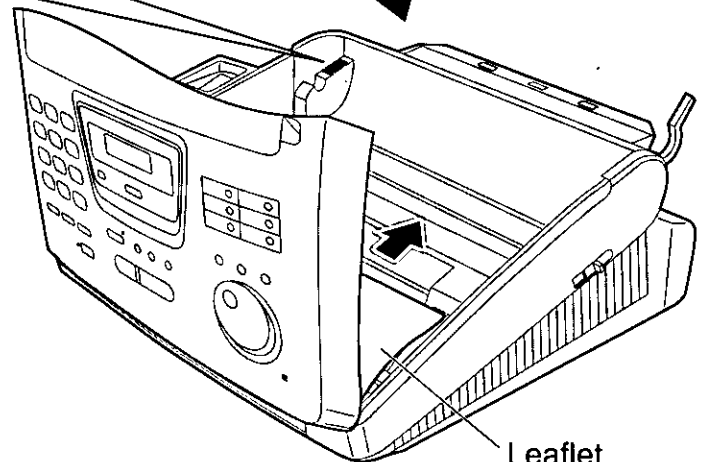

Leaflet

2

Stacker (See page 21.)

- A. Lift the front of the unit, insert the stacker into the slots and slide it until it stops.

3

Paper tray (See page 22.)

- A. Open the paper tray.
B. Insert the two tabs on the paper tray into the slots on the back of the unit.

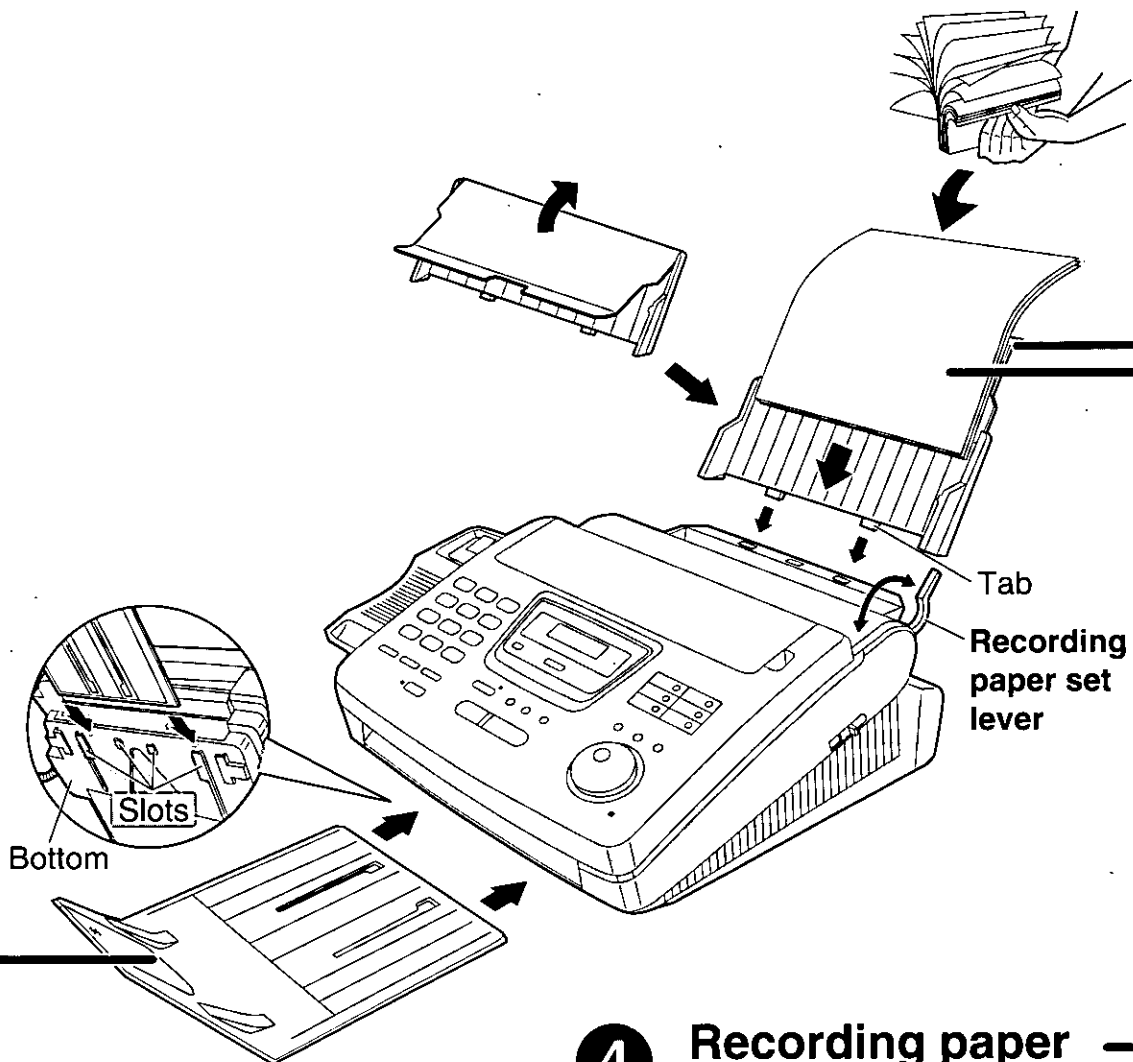

4

Recording paper (See page 22.)

- A. Pull the recording paper set lever forward.
B. Fan the stack of paper to prevent a paper jam and insert the paper into the paper tray.
C. Move the recording paper set lever back.

Quick Start

Connections

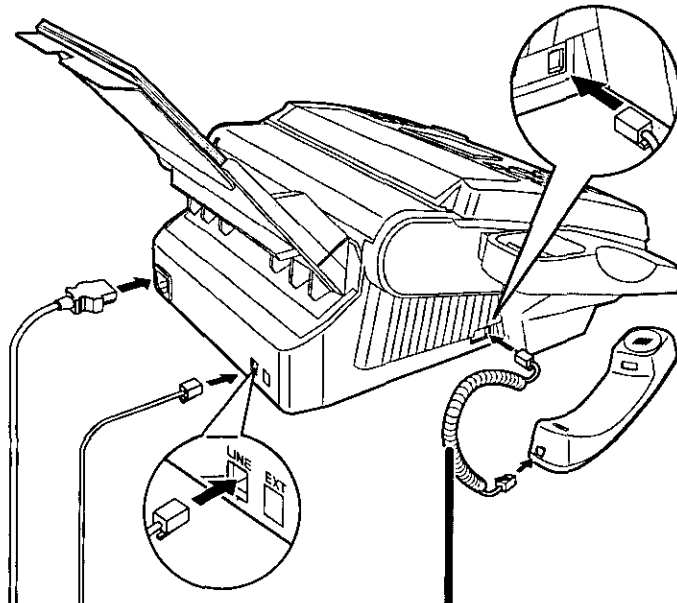

1 Handset cord

- A. Connect to the unit.
- B. Connect to the handset.

2 Telephone line cord

- A. Connect to "LINE" on the unit.
- B. Connect to a single telephone line jack.

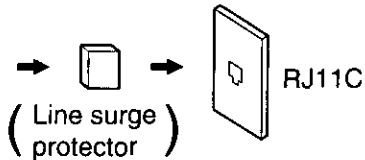

3 Power cord

- A. Connect to the unit.
- B. Connect to a power outlet.

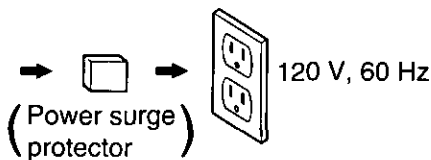

● For further details, see page 24.

Voice call - making/answering

Voice call - making

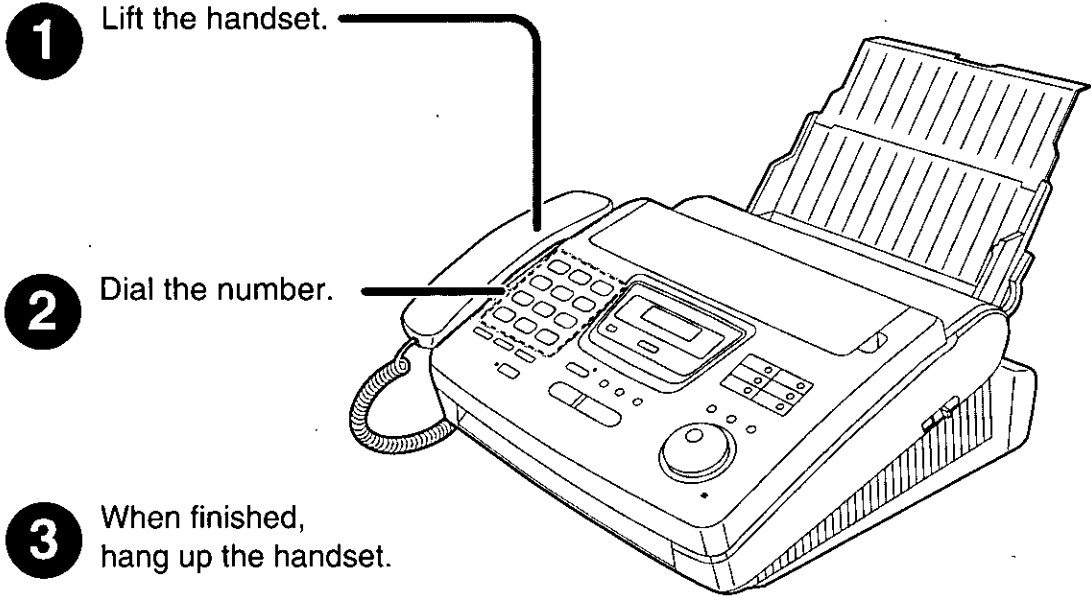

- For further details, see page 30.
- If you have a trouble, see page 81.

Voice call - answering

- 1** When the unit rings, lift the handset.

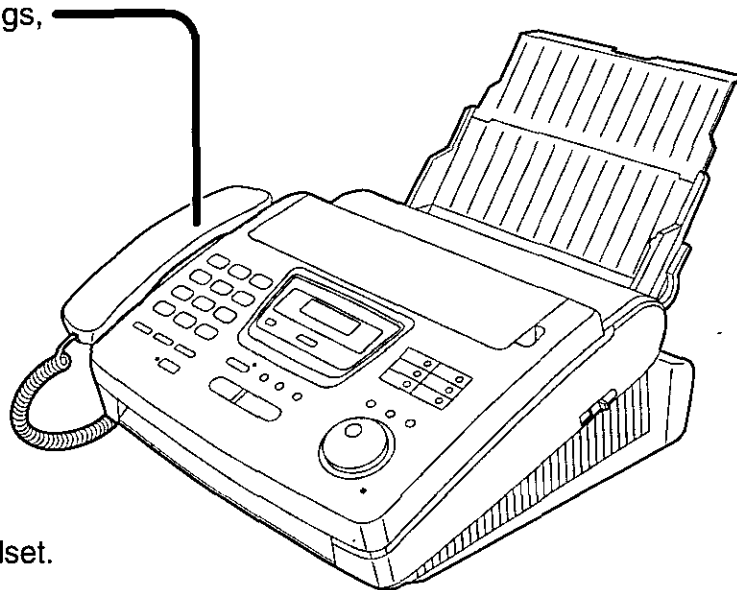

- 2** When finished, hang up the handset.

- For further details, see page 31.
- If you have a trouble, see page 81.

Fax - sending/receiving

Fax - sending

- 1 Open the document feeder tray.

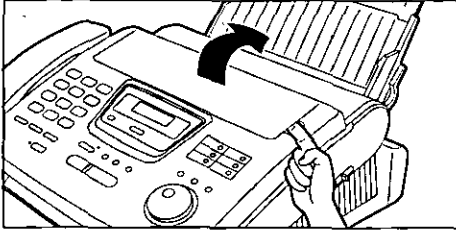

- 2 Adjust the width of the document guides to the size of the document.

- 3 Insert the document until a single beep is heard and the unit grabs the document.

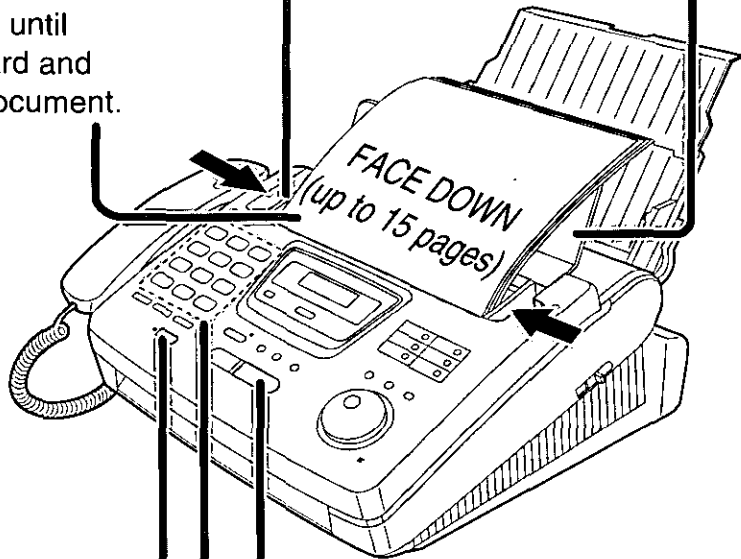

- 4 Press **SP-PHONE**.

- 5 Dial the fax number.

- 6 When a fax tone is heard, press **START/COPY/SET**.

- For further details, see page 41.
- If you have a trouble, see pages 81 and 82.

Quick Start

Fax - receiving

- 1 When the unit rings, lift the handset.

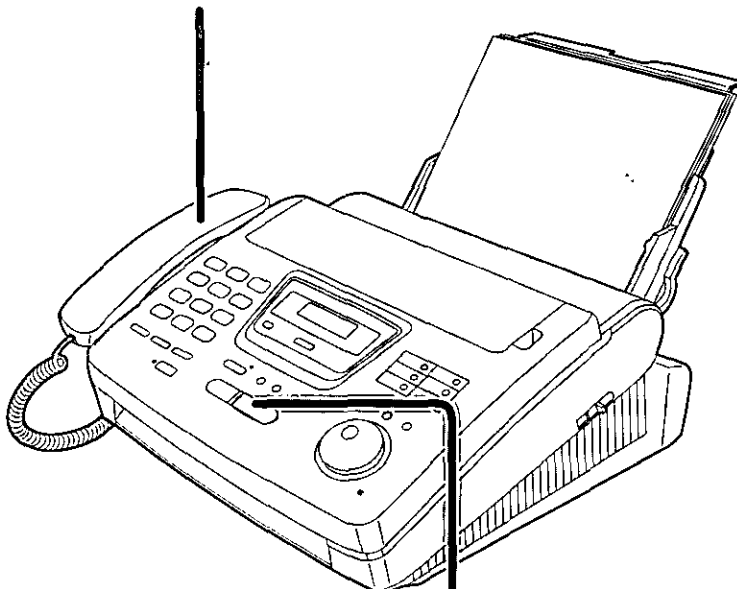

- 2 When:
 - document reception is required,
 - a fax calling tone (slow beep) is heard, or
 - no sound is heard,press **START/COPY/SET**.

- 3 Hang up the handset.

- For further details, see page 58.
- You can select the desired option to receive calls according to your needs. See pages 56 and 57.
- If you have a trouble, see page 82.

Copy - making

- 1 Open the document feeder tray.

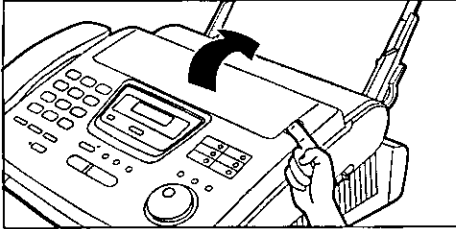

- 2 Adjust the width of the document guides to the size of the document.

- 3 Insert the document until a single beep is heard and the unit grabs the document.
 - Make sure the handset is hung up.

- 4 Press **START/COPY/SET**.

- 5 Enter the number of copies (up to 99).

- 6 Press **START/COPY/SET**.

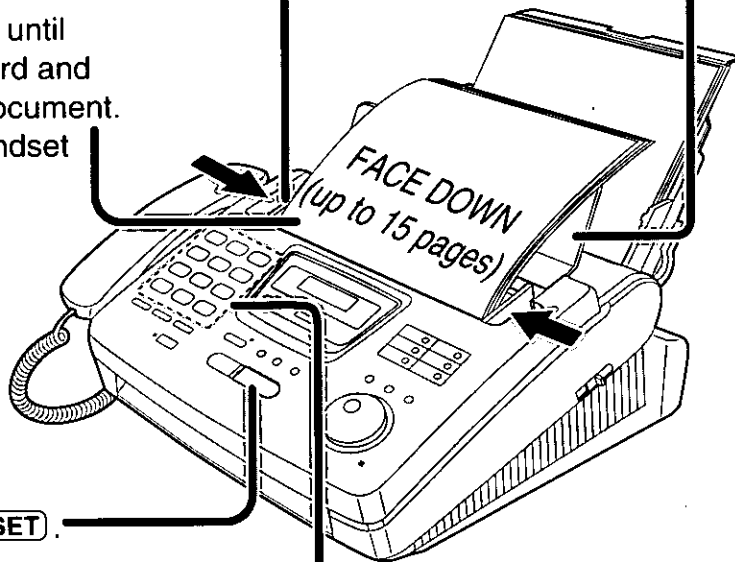

- For further details, see page 76.
- If you have a trouble, see page 83.

Table of Contents

Initial Preparation	Accessory	Included accessories	14
		Accessory order information	14
	Help Button	Help function	15
	Finding the Controls	Location	16
		Overview	18
	Setup	Film cartridge	19
		Stacker	21
Paper tray		22	
Recording paper		22	
Connections		24	
Date and time, your name and facsimile telephone number		25	
Volume	Adjusting volumes	29	
Telephone	Making and Answering Calls	Voice call - making	30
		Voice call - answering	31
		TONE, FLASH and PAUSE buttons	32
		Dialing mode (touch tone or pulse)	33
	One-Touch Dial	Storing names and telephone numbers in One-Touch Dial	34
		Making a voice call using One-Touch Dial	36
	JOG DIAL	Storing names and telephone numbers in the JOG DIAL directory	37
		Making a voice call using the JOG DIAL directory	39
	Voice Contact	Talking to the caller after fax transmission or reception	40
	Fax/Copy	Sending Faxes	Sending a fax manually
Sending a fax using One-Touch Dial			42
Sending a fax using the JOG DIAL directory			43
IQ-FAX			44
Documents you can send			47
Confirmation report			48
Automatic journal report printing			49
Delayed transmission (sending a fax at a specific time)			50
From memory			51
Multiple stations			52
Overseas			54
Connecting tone			55
Receiving Faxes			Setting the unit to receive calls
		TEL mode (answering all calls manually)	58
		FAX ONLY mode (all calls are received as faxes)	59
		Using with an answering machine	61
		Distinctive Ring service (ring pattern detection feature)	64
	TEL/FAX mode (receiving voice calls with rings and fax calls without rings when you are near the unit)	66	
	Extension telephone	70	
	Fax activation code	70	



(continued)

Fax/Copy	Receiving Faxes	Other size documents	71	Initial Preparation
		Silent detection (receiving faxes from older model fax machines)	72	
		Memory reception alert	73	
		Friendly reception	73	
		Pager call - when your unit receives a fax	74	
		Film detection	75	
	Copying	Making a copy	76	
Help	Error Messages	Printed reports	78	Telephone
		LCD display	79	
	Operations	When a function does not work, check here before requesting help	81	
		If a power failure occurs	84	
	Jams	Recording paper jam	85	Fax/Copy
		Sending document jams	87	
		Sending documents does not feed, or multi-feeds	87	
	Ink Film	How much film you have left	88	
		Replacing the film or film cartridge	88	
	Cleaning	Document feeder	90	
	Thermal head and black bar	90		
General Information	Reports	Printing the feature settings, telephone numbers, the journal and printer test list	91	Help
	Display Contrast	Changing the LCD display contrast	92	
	Reset	Resetting the advanced features	92	
	FCC Information	List of FCC requirements and information	93	
	Warranty	Limited Warranty	94	
		Servicenter Directory	95	
		Notes for product service and shipping the product	96	
Specifications	Technical data about this product	97	General Information	
Comienzo rápido en español	Comienzo rápido en español	98		
Comienzo rápido en español	Index	108	Comienzo rápido en español (p. 98)
	Features Summary	Summary of user programmable features	110	

Accessory

Included accessories

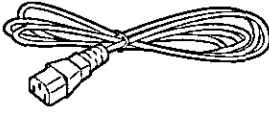
To order, call toll free 1-800-435-7329 or see the fax order instructions below.

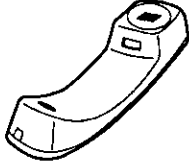
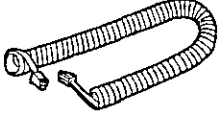
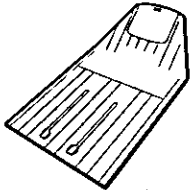
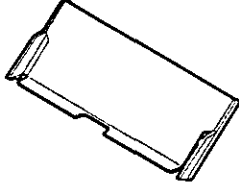
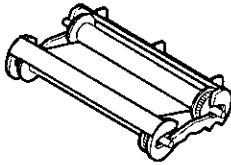
<p>Power cord..... 1 pc. Part No. PQJA200Z</p> 	<p>Telephone line cord 1 pc. Part No. PQJA59V</p> 	<p>Handset 1 pc. Part No. PFJXE0105Z</p> 	<p>Handset cord..... 1 pc. Part No. PQJA212M</p> 
<p>Stacker 1 pc. Part No. PFZE1FP250M</p> 	<p>Paper tray 1 pc. Part No. PFYEFP200M</p> 	<p>Film cartridge..... 1 pc. (with free starter film)</p> 	

- If any items are missing or damaged, check with the place of purchase.
- The part numbers listed above are subject to change without notice.
- Save the original carton and packing materials for future shipping and transportation of the unit.

Accessory order information

The free starter film is only 20 meters (65') long. We recommend that you buy regular film [100 m (328')] for uninterrupted use of your unit.

For best results, use Panasonic replacement film, KX-FA135 or KX-FA136.

To order, call toll free 1-800-435-7329 or see the fax order instructions below.

Fax order: Please send a fax to 1-800-237-9080. Include: Your name, shipping address, telephone number, credit card type, number, expiration and your signature, order part number and quantity, delivery method – overnight, 2nd day, or ground.

Model No.	Description	Specifications
KX-FA135	Film cartridge	1 cartridge and 1 film [216 mm x 100 m (8½" x 328') roll] (The film has already been installed in the cartridge.)
KX-FA136	Replacement film	2 films [216 mm x 100 m (8½" x 328') rolls] (Film only. Use with your original cartridge.)

Note:

- **The film is not reusable. Do not rewind and use the film again.**
- The films above can be used for your unit even though the model number of your unit (KX-FP250/KX-FP245) is not listed on the film's box.

Help function

You can print a quick reference for assistance as follows.

- 1** Select which operation you want to print out by pressing **HELP** repeatedly.

Display: **PRESS [▼▲] & [SET]**

- 2** Press **▼** or **▲** until the desired item is displayed. The following items are available.

1. How to program your unit

1. HOW TO SET UP

2. How to store names in the JOG DIAL directory and how to dial them

2. JOG/AUTO DIAL

3. Help with problems sending faxes

3. FAX SENDING

4. Help with problems receiving faxes

4. FAX RECEIVING

5. How to use the copier function

5. COPIER

6. Frequently asked questions and the answers

6. Q and A

7. Explanation of some error messages shown on the display

7. ERRORS

8. List of available reports

8. REPORTS

- 3** Press **START/COPY/SET**.

PRINTING

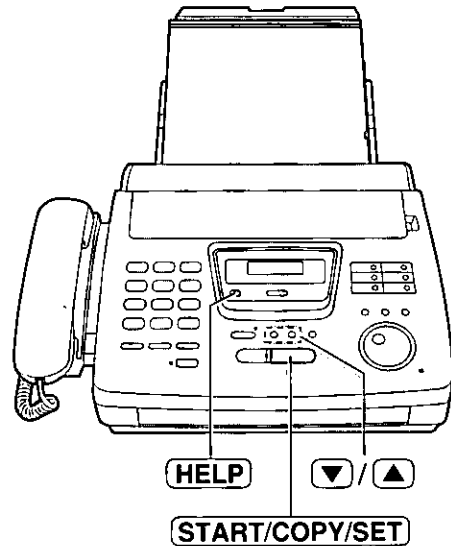

Note:

- When you press **HELP** during programming, the unit will print out a quick reference for that feature.

Finding the Controls

Location

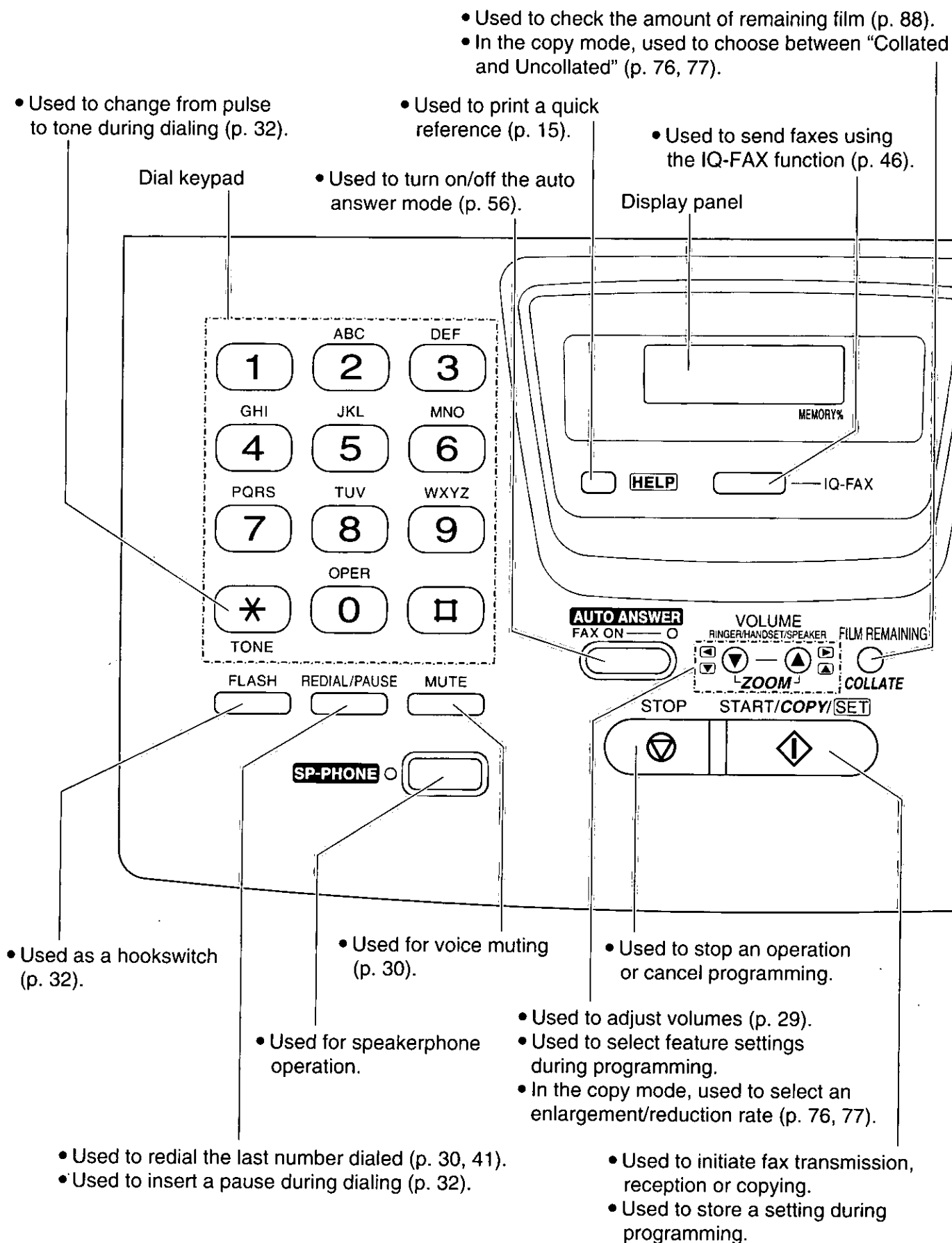

Finding the Controls

• Used to select a resolution (p. 41).

• Used for transmission to multiple stations (p. 52, 53).
 • Used to insert a hyphen (p. 27, 34, 35).

• Used to insert one character or one space (p. 26, 27, 35).

• Used for One-Touch Dial (p. 34, 36, 42).
 • Used as command keys (p. 27, 35).

• Used to confirm a stored telephone number (p. 39).
 • Used to select stations 6-10 for One-Touch Dial (p. 34, 36, 42).

• Used to keep the telephone number secret (p. 34, 35, 37).

• Used to store or edit names and telephone numbers (p. 34, 37, 38, 52).

• Used to initiate or exit programming.

• Used to talk with the other party when using the speakerphone.

• Used to search for a stored name (p. 39, 43).
 • Used to select characters during programming (p. 27, 35).
 • Used to select the basic features during programming (p. 110).

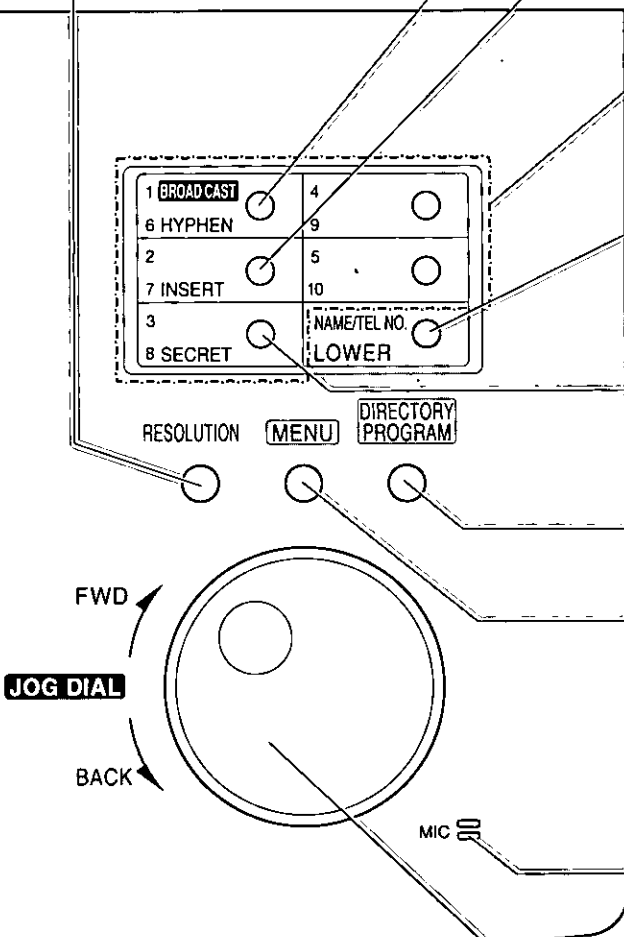

Finding the Controls

Overview

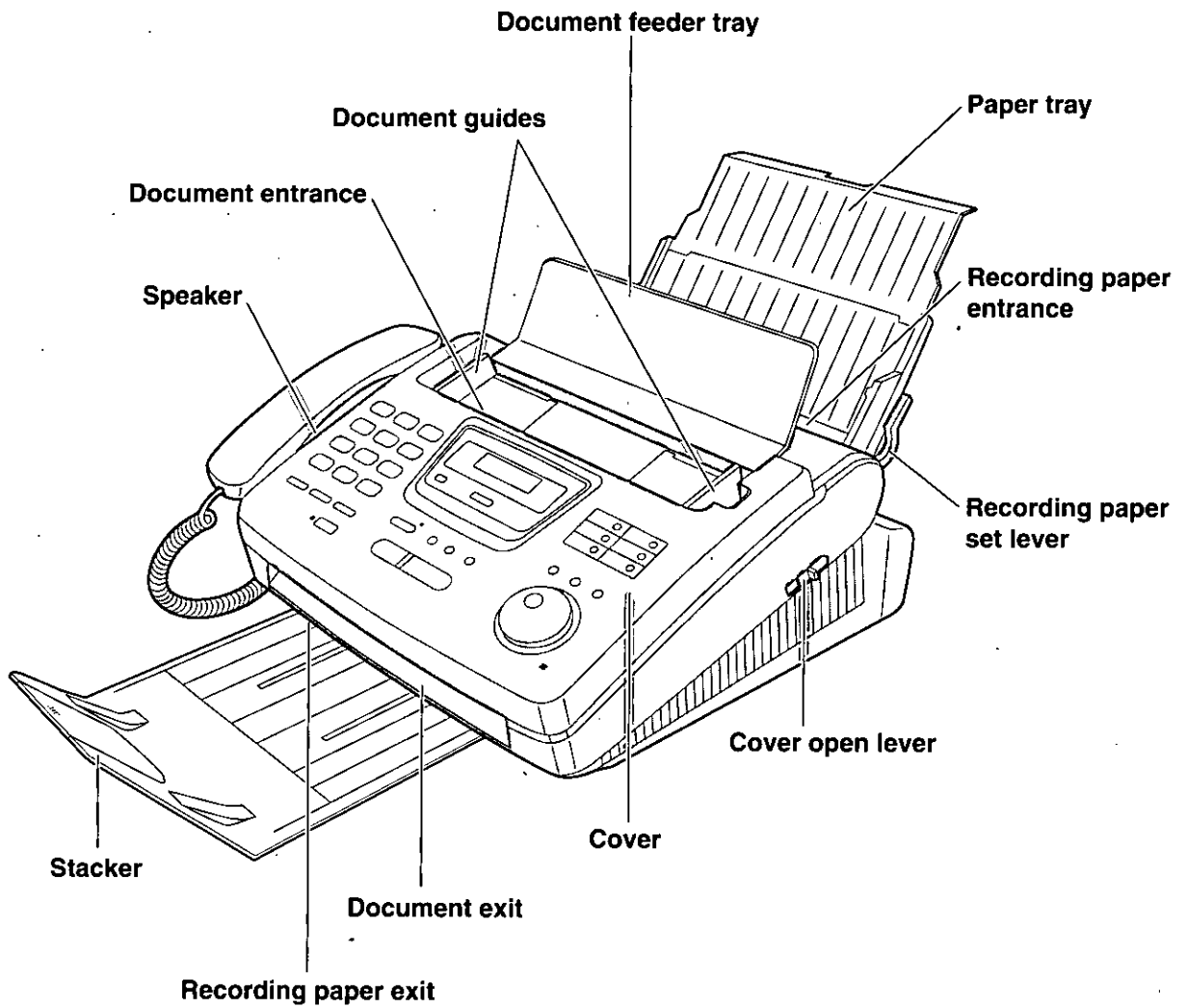

Film cartridge

The free starter film prints about 65 letter size pages. A normal film roll prints about 330 letter size pages. Purchase one of the following full size replacement film kits as soon as possible for uninterrupted use of your Panasonic plain paper fax machine.

Full size replacement film kits:

- **KX-FA135 Film cartridge** Complete kit includes: Film roll, gears and cartridge. (prints about 330 letter size pages)
- **KX-FA136 Replacement film** Two replacement film rolls only. Use these film rolls to refill the cartridge. (prints a total of about 660 letter size pages)

Caution:

- The film can only be used once. When the unit displays "FILM EMPTY", refill or replace the cartridge with one of the above kits (see page 14 for ordering instructions). If the film is rewound, the print quality will be greatly reduced, and the unit may jam.

- 1** Remove the shipping tape from the unit.

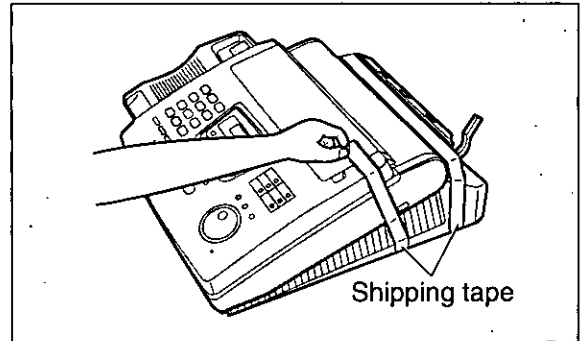

- 2** Slide the cover open lever forward.

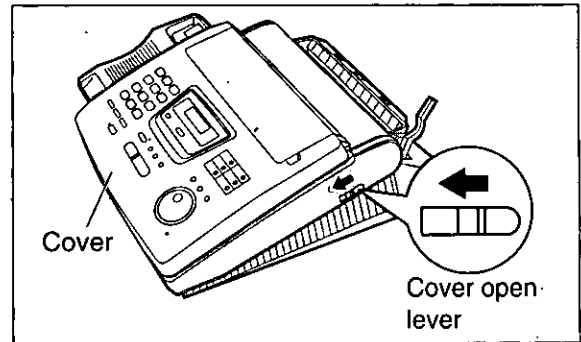

- 3** The cover is under tension to improve print quality. Pull up hard enough to open.

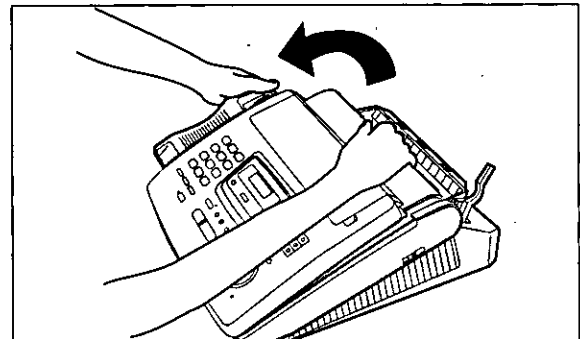

(continued)

Setup

- 4** Remove the leaflet from the unit.

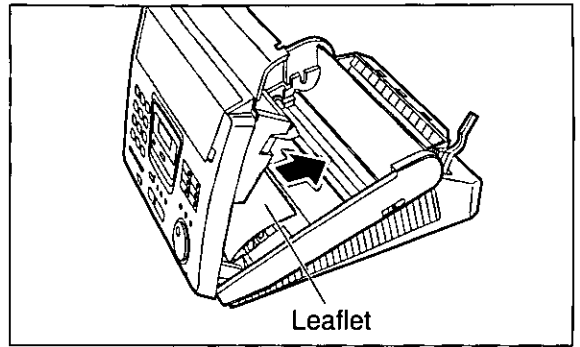

- 5** If the film in the film cartridge is slack, tighten it by winding the bottom side gears.

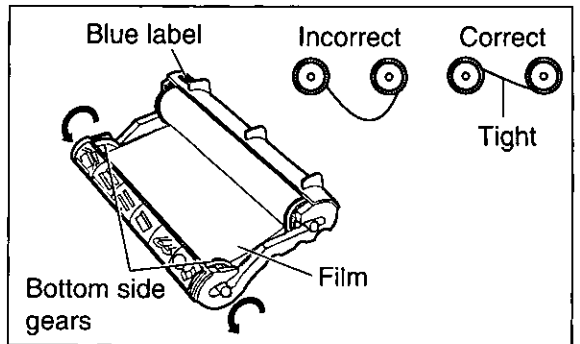

- 6** Install the film cartridge into the unit.

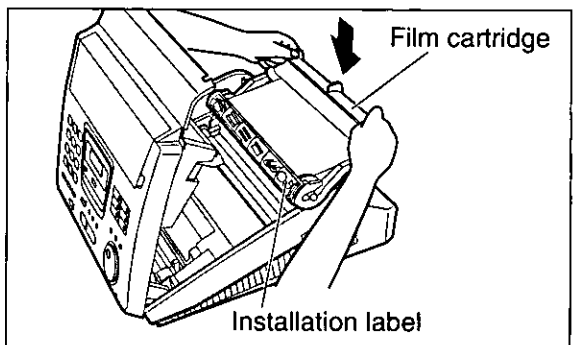

- 7** Make sure that the blue label on the cartridge matches the one on the unit.

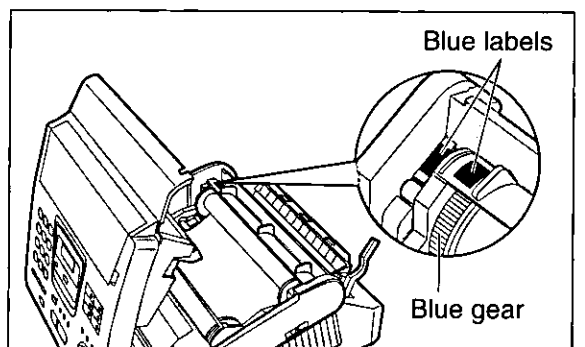

- 8** Close the cover securely by pushing down on both corners.

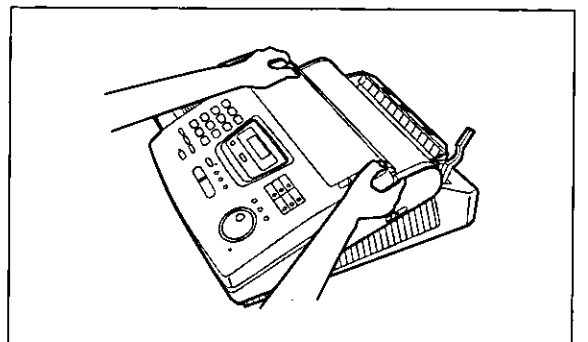

Stacker

- 1** Remove the shipping tape from the stacker.
- 2** Lift the front of the unit, insert the stacker into the slots.
- 3** Confirm the stacker is locked with the center slots.
- 4** Slide the stacker until it stops.

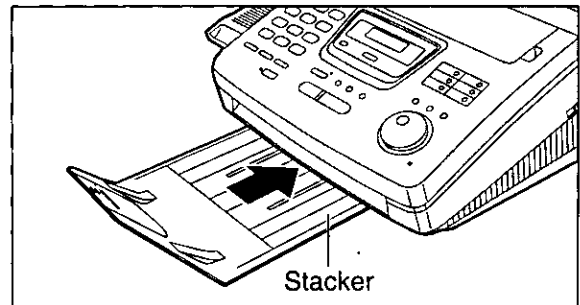
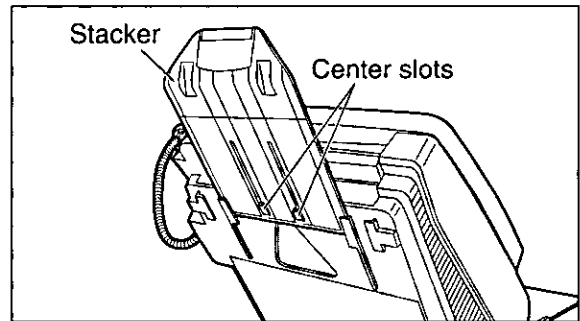
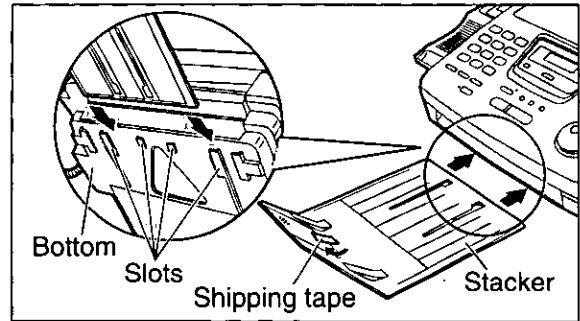

Using legal size paper

- 1** Press the dotted area on the stacker extender.
- 2** Open the stacker extender.

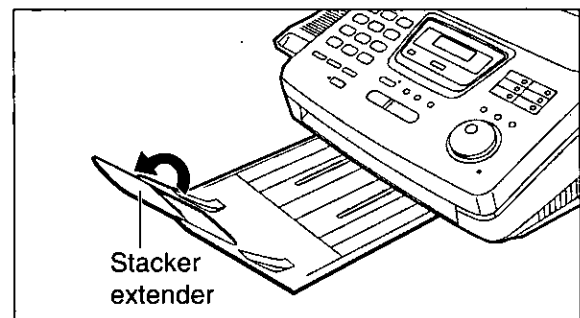
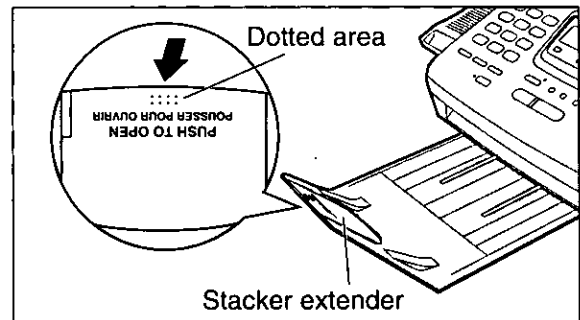

Setup

Paper tray

- 1 Open the paper tray.

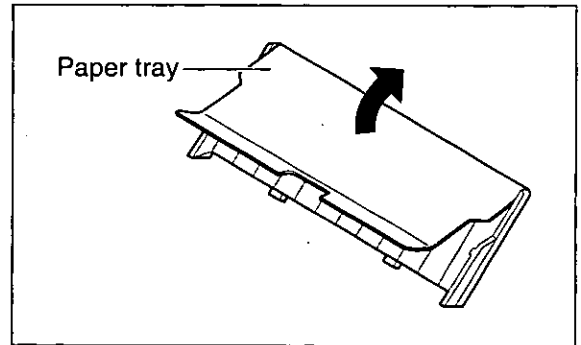

- 2 Insert the two tabs on the paper tray into the slots on the back of the unit.

- Do not place the unit in areas where the paper tray may be obstructed by walls, etc.

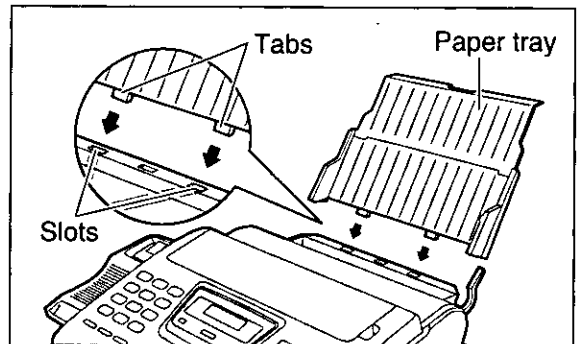

Recording paper

Letter or legal size recording paper can be loaded. The paper tray can hold up to 150 sheets of 75 g/m² (20 lb.) paper. You may use 60 g/m² to 90 g/m² (16 lb. to 24 lb.) paper.

For best results, use inkjet paper like Hammermill® Jet Print only. If you use other types of paper, the print quality may be affected.

- 1 Pull the recording paper set lever forward.

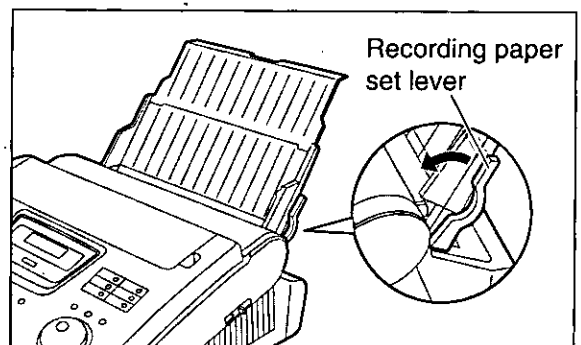

- 2** Fan the stack of paper to prevent a paper jam and insert the paper into the paper tray.
- The height of the stack of the paper should not exceed the upper limit on the paper tray, otherwise a paper jam or multi-feed may occur.
 - The paper should not be over the tab.
 - If the paper is not inserted correctly, readjust the paper or a paper jam may occur.

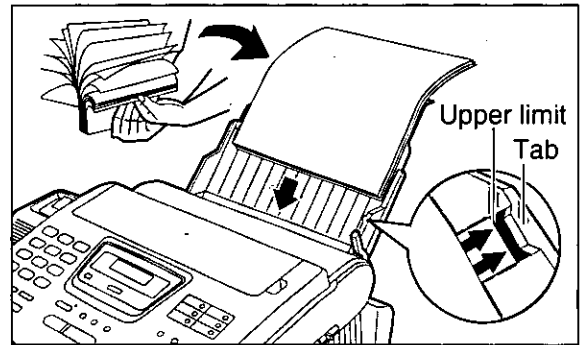
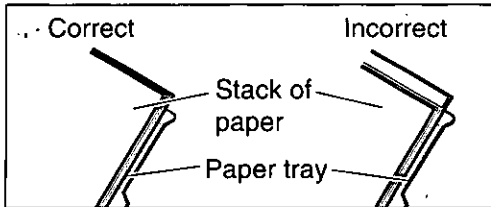

- 3** Move the recording paper set lever back.

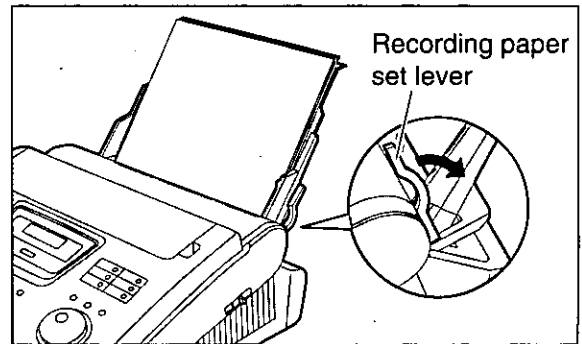

Note:

- Avoid paper with a cotton and/or fiber content that is over 20%, such as letterhead paper or those used for resumes.
- Do not use different types or thicknesses of paper in the paper tray at the same time. This may cause a paper jam.
- Avoid extremely smooth or shiny paper that is highly textured. Also avoid paper that is coated, damaged or wrinkled.
- Avoid double-sided printing.
- Do not use paper printed from this unit for double-sided printing with other copiers or printers, or a paper jam may occur.

Adding paper to the paper tray

1. Pull the recording paper set lever forward.
 - The unit will beep and the following message is displayed.

Display: CHECK LEVER

2. Remove the installed paper.
3. Add paper to the removed paper and straighten it.
4. Fan the stack of paper and insert it into the paper tray.
5. Move the recording paper set lever back.

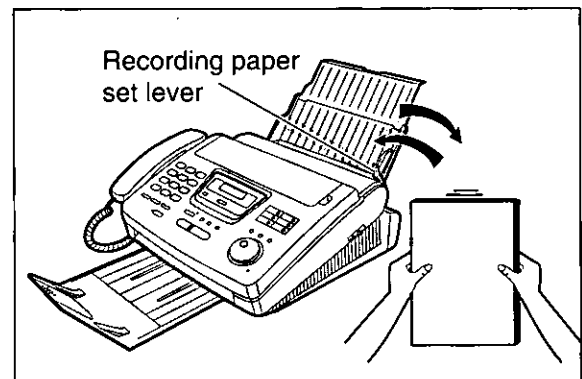

Setup

Connections

1 Connect the handset cord.

2 Connect the telephone line cord.

3 Connect the power cord.
• When the power is turned on for the first time, the unit will print some basic information.

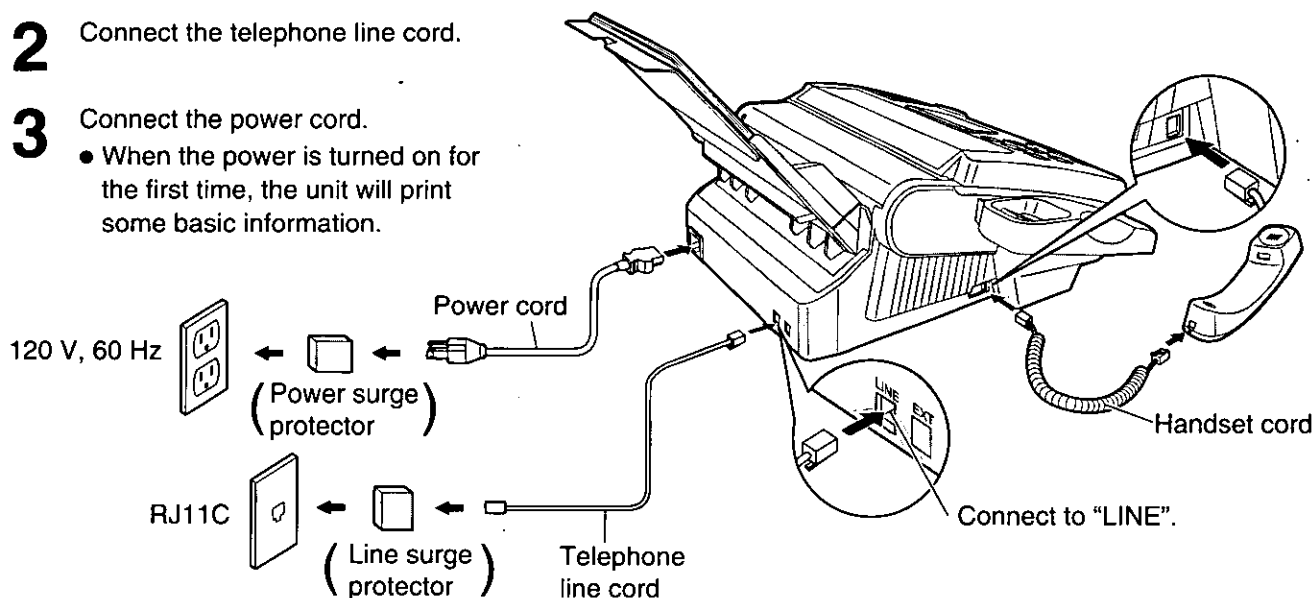

Note:

- The warranty does not cover damage due to power line surges or lightning. For additional equipment protection, we recommend the use of a surge protector. The following types are available; TELESPIKE BLOK MODEL TSB (TRIPPE MFG. CO.), SPIKE BLOK MODEL SK6-0 (TRIPPE MFG. CO.), SUPER MAX (PANAMAX) or MP1 (ITW LINX).
- When you operate this product, the power outlet should be near the product and easily accessible.
- If the following message is displayed when the unit is plugged in, the recording paper set lever is released.

Display: CHECK LEVER

Move the lever back (see step 3 on page 23).

Automatic dialing mode setting

- When the telephone line cord and the power cord are connected, the unit will automatically start to detect the dialing mode.

Display: CHECKING LINE

Wait until one of the following messages is displayed.

— If your line has touch tone service:

LINE IS TONE

— If your line has rotary pulse dial service:

LINE IS PULSE

- If the power cord is disconnected or a power failure occurs, the unit will detect the dialing mode again when power is restored.
- You can change the dialing mode setting manually. See page 33.
- If you connect the power cord before connecting the telephone line cord, the following messages will be shown alternately.

Display: INSERT TEL LINE ↔ NO TEL LINE

Connect the telephone line cord.

Date and time, your name and facsimile telephone number

You should program the date and time, your logo and facsimile telephone number. This information will be printed on each page transmitted from your unit, fulfilling the requirements of the Telephone Protection Act of 1991.

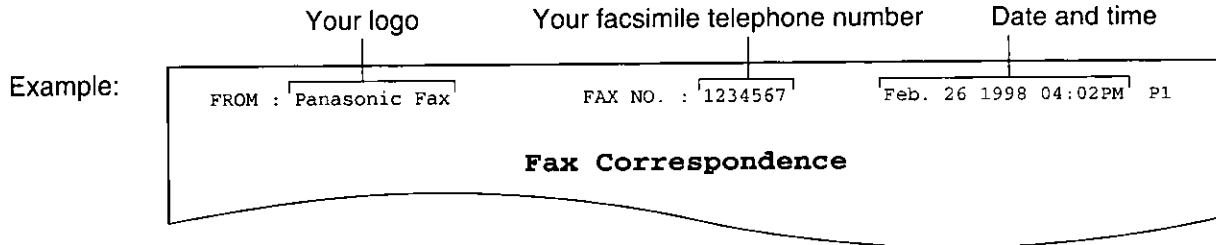

Setting the date and time

1 Press **MENU**.
Display: 1.SYSTEM SET UP

2 Press **⏏**, then **0 1**.
SET DATE & TIME

3 Press **START/COPY/SET**.
M: 01 / D: 01 / Y: 98
Cursor

4 Enter the correct month/day/year by selecting each 2 digits using the dial keypad or **JOG DIAL**.
If using **JOG DIAL**, press **▶** to move the cursor.
Example (using the dial keypad): Aug. 10, 1998
Press **0 8 1 0 9 8**.
M: 08 / D: 10 / Y: 98

5 Press **START/COPY/SET**.
TIME: 12:00AM

6 Enter the correct hour/minute by selecting each 2 digits using the dial keypad or **JOG DIAL**.
If using **JOG DIAL**, press **▶** to move the cursor.
Press ***** to select "AM" or "PM".
Example (using the dial keypad): 3:15PM
1. Press **0 3 1 5**.
TIME: 03:15AM

2. Press ***** until "PM" is displayed.
TIME: 03:15PM

7 Press **START/COPY/SET**.
SETUP ITEM []

8 Press **MENU**.

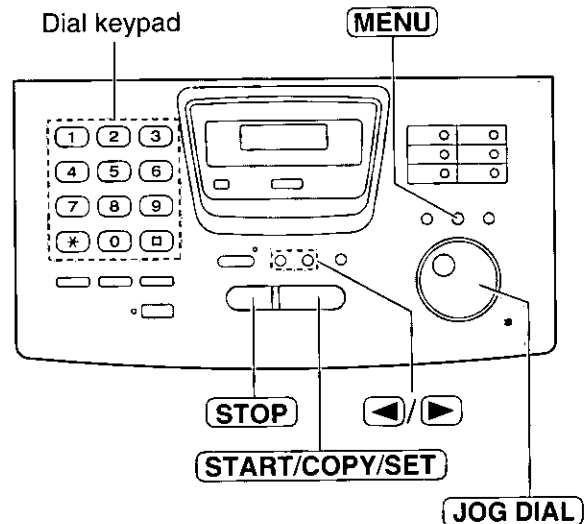

Note:

- The ***** key can be used to select "AM" or "PM" wherever the cursor is located.
- The accuracy of the clock is approximately ± 60 seconds a month.

To correct a mistake

- Press **◀** or **▶** to move the cursor to the incorrect number, then make the correction.
- If you press **STOP** while programming, the display will return to the previous one.

Setup

Setting your logo

The logo can be your company, division or name.

1 Press **MENU**.
Display: 1.SYSTEM SET UP

2 Press **□**, then **0 2**.
YOUR LOGO

3 Press **START/COPY/SET**.
LOGO=

4 Enter your logo, up to 30 characters, by using the dial keypad or **JOG DIAL** (see the next page).

Example (using the dial keypad): Bill

1. Press **2** twice. LOGO=B
Cursor

2. Press **4** six times. LOGO=Bi

3. Press **5** six times. LOGO=Bi_

4. Press **▶** to move the cursor to the next space and press **5** six times.

LOGO=Bill_

5 Press **START/COPY/SET**.
SETUP ITEM []

6 Press **MENU**.

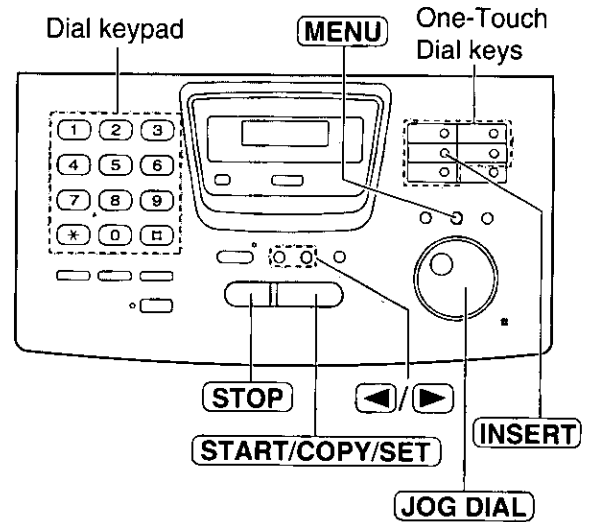

To correct a mistake

- Press **◀** or **▶** to move the cursor to the incorrect character, then make the correction.

To delete a character

- Move the cursor to the character you want to delete and press **STOP**.

To insert a character

1. Press **◀** or **▶** to move the cursor to the position to the right of where you want to insert the character.
2. Press **INSERT** (One-Touch Dial key 2) to insert a space and enter the character.

To select characters with the dial keypad

Pressing the dial keys will select a character as shown below.

Keys	Characters
(1)	1 [] { } + - / = , . _ ' : ; ?
(2)	A B C a b c 2
(3)	D E F d e f 3
(4)	G H I g h i 4
(5)	J K L j k l 5
(6)	M N O m n o 6
(7)	P Q R S p q r s 7
(8)	T U V t u v 8
(9)	W X Y Z w x y z 9
(0)	0 () < > ! " # \$ % & ¥ * @ ^ ' →
One-Touch Dial keys	HYPHEN key (Used to insert a hyphen.)
	INSERT key (Used to insert one character or one space.)
Arrow keys	◀ key (Used to move the cursor to the left.)
	▶ key (Used to move the cursor to the right.) To enter another character using the same number key, move the cursor to the next space.

To select characters using the JOG DIAL

Instead of pressing the dial keys, you can select characters using the JOG DIAL.

1. Rotate **JOG DIAL** until the desired character is displayed.
2. Press to move the cursor to the next space.
 - The character displayed in step 1 is inserted.
3. Return to step 1 to enter the next character.

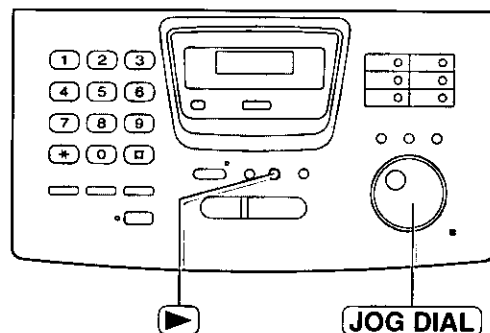

Display order of characters

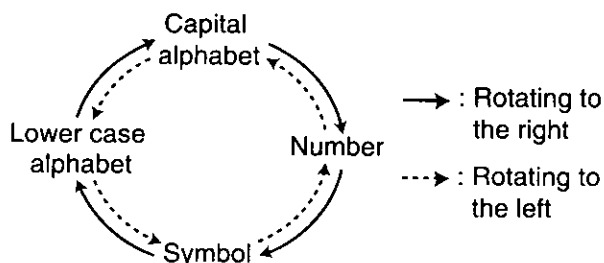

Setup

Setting your facsimile telephone number

- 1** Press **MENU**.
Display: 1.SYSTEM SET UP
- 2** Press **□**, then **0 3**.
YOUR FAX NO.
- 3** Press **START/COPY/SET**.
NO.=
- 4** Enter your facsimile telephone number up to 20 digits using the dial keypad or **JOG DIAL**.
If using **JOG DIAL**, press **▶** to move the cursor.
Example: NO.=1234567
- 5** Press **START/COPY/SET**.
SETUP ITEM []
- 6** Press **MENU**.

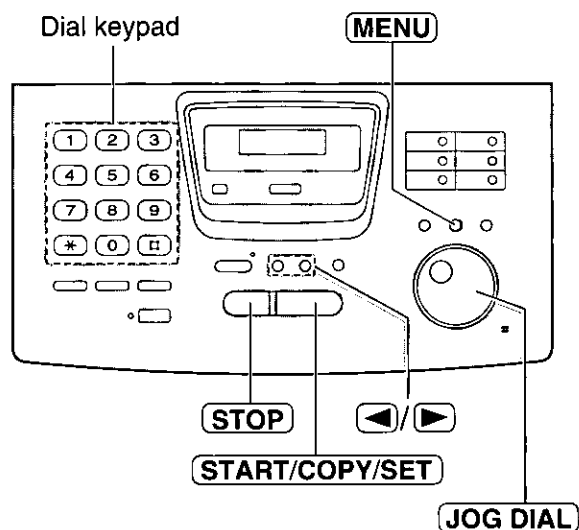

Note:

- The **□** button replaces with a space and the ***** button replaces with a “+”.

Example (using the dial keypad): +234 5678

Press ***234□5678**.

To correct a mistake

- Press **◀** or **▶** to move the cursor to the incorrect number, then make the correction.

To delete a number

- Move the cursor to the number you want to delete and press **STOP**.

Adjusting volumes

Ringer volume

4 levels (high/middle/low/off) are available.

While the unit is idle, press ▼ or ▲.

■ To turn the ringer off:

1. Press ▼ repeatedly until the following message is displayed.

Display: RINGER OFF= OK?



YES: PRESS SET

2. Press START/COPY/SET.

- To turn the ringer back on, press ▲.

■ While the ringer volume is set to off:

The display will show the following message.

RINGER OFF

When receiving a call, the unit will not ring and will display the following.

INCOMING CALL

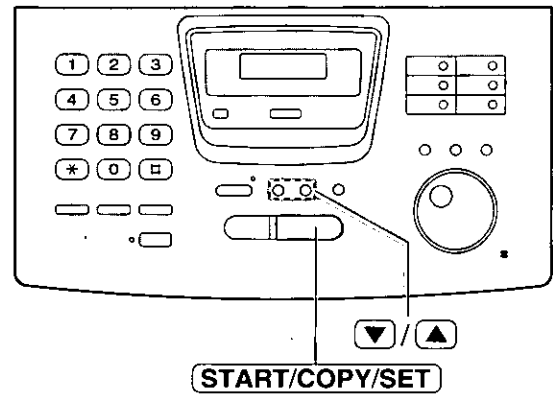

Handset receiver volume

5 levels (high to low) are available.

While using the handset, press ▼ or ▲.

Speaker volume

8 levels (high to low) are available.

While using the speakerphone, press ▼ or ▲.

Making and Answering Calls

Voice call - making

- 1 Press **SP-PHONE** or lift the handset.
Display:
- 2 Dial the telephone number.
Example:
 - If you misdial, hang up and dial again.
- 3 When the other party answers, talk into the microphone or handset.
- 4 When finished, press **SP-PHONE** or hang up the handset.

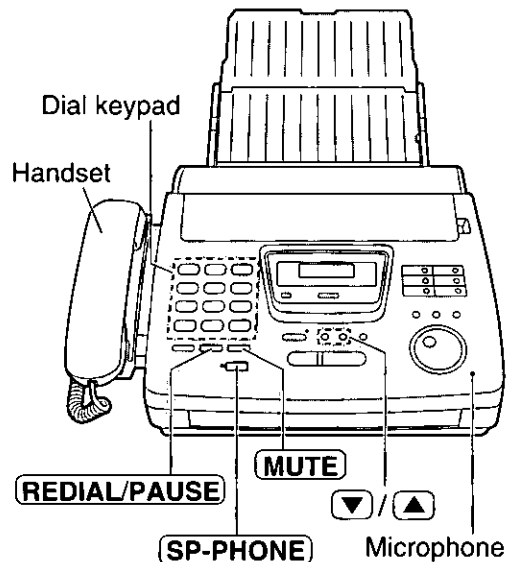

To redial the last number

1. Press **SP-PHONE** or lift the handset.
2. Press **REDIAL/PAUSE**.
 - If the line is busy when using the **SP-PHONE** button, the unit will automatically redial the number up to 14 times.
 - During redial, the following will be displayed.

Display:

To mute your voice to the other party

1. Press **MUTE** during a telephone conversation.

Display:

- The other party cannot hear you, but you can hear them.
2. To resume the conversation, press **MUTE**.

Hints for speakerphone operation

- Use the speakerphone in a quiet room.
- If you have difficulty hearing the other party, adjust the volume using **▼** or **▲**.
- If you and the other party speak at the same time, parts of your conversation will be cut off.
- To switch to the handset, lift the handset. To switch back to the speakerphone, press **SP-PHONE**.

Making and Answering Calls

Voice call - answering

- 1** When the unit rings, press **SP-PHONE** or lift the handset.
- 2** When finished, press **SP-PHONE** or hang up the handset.

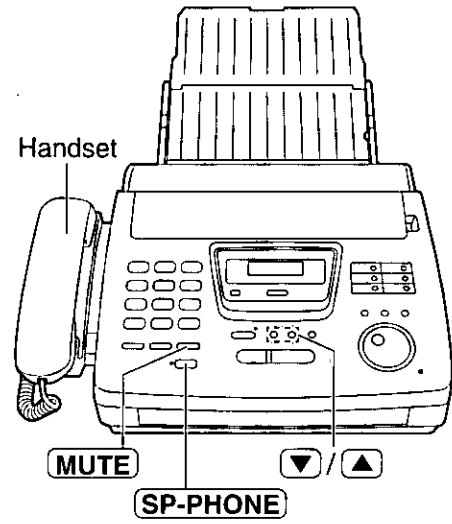

Making and Answering Calls

TONE, FLASH and PAUSE buttons

TONE button

The **TONE** (*) button is used for rotary pulse dial services and allows you to temporarily change from the pulse to tone mode during a dialing operation. When you hang up, the unit will automatically return to the pulse mode.

FLASH button

The **FLASH** button functions as the hookswitch on a regular telephone. If you misdial a telephone number, press the **FLASH** button firmly.

The **FLASH** button also allows you to use special features of a host exchange (if connected) or local telephone company services such as call waiting. For further details, contact your host exchange supplier or local telephone company.

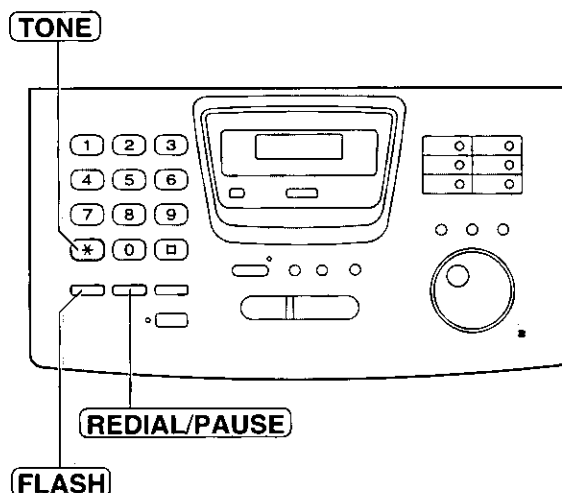

Note:

- TONE, FLASH and PAUSE can be stored into a telephone number in One-Touch Dial and the JOG DIAL directory.

Entering pauses

When the **REDIAL/PAUSE** button is pressed during dialing, a pause will be inserted. Pressing **REDIAL/PAUSE** once creates a 5 second pause.

Example 1:

When your unit is connected to a host exchange, insert a pause before the telephone number to get an outside line.

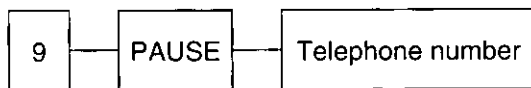

Line access code

Example 2:

If a transmission error occurs during an overseas transmission, add two pauses at the end of the telephone number.

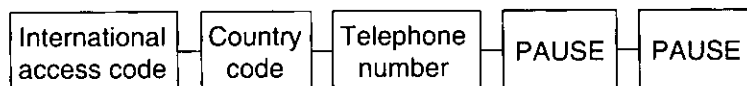

Making and Answering Calls

Dialing mode (touch tone or pulse) =====

The unit will automatically set the dialing mode to "TONE" or "PULSE" when the unit is turned on if this feature is set to "AUTO".

If you cannot dial, change the dialing mode setting to "TONE" or "PULSE" by following the instructions below.

- 1** Press **MENU**.
Display: 1. SYSTEM SET UP
- 2** Press **□**, then **1** **3**.
DIALING MODE
- 3** Press **START/COPY/SET**.
MODE=AUTO ▼▲
- 4** Press ▼ or ▲ to select the desired setting.
- 5** Press **START/COPY/SET**.
SETUP ITEM []
- 6** Press **MENU**.

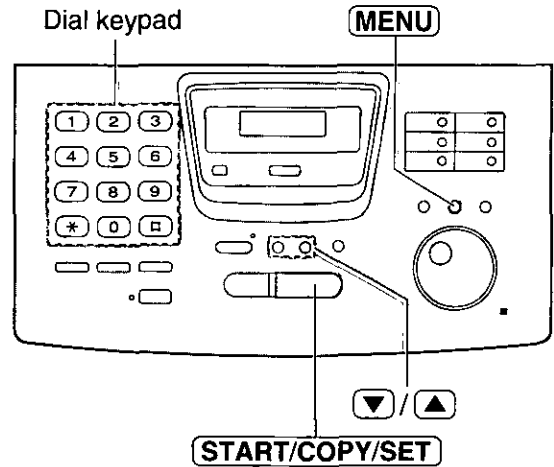

Note:

- If you change to a different telephone company and this company has a different dialing mode service, reset your dialing mode.

One-Touch Dial

Storing names and telephone numbers in One-Touch Dial

The unit's memory allows you to use One-Touch Dial for rapid access to your most frequently dialed numbers. 10 stations are available.

- The One-Touch Dial key 1 can be used as One-Touch Dial key 1 (DIAL MODE) or as a broadcast key (BROADCAST). Both functions cannot be used at the same time. For the broadcast function, see pages 52 and 53.

1 Press **DIRECTORY PROGRAM**.

Display: PRESS STATION

↑↓

OR USE JOG-DIAL

2 For stations 1–5
Press one of the One-Touch Dial keys.

- If you select One-Touch Dial key 1, select "DIAL MODE" by pressing **▼**. Then press **START/COPY/SET** to go to the next prompt.

For stations 6–10
Press **LOWER**, then press one of the One-Touch Dial keys.

3 Enter the station name, up to 10 characters, by following the instructions on the next page.

Example: NAME=John

4 Press **START/COPY/SET**.

Example: <S02>=

5 Enter the telephone number up to 30 digits.

- To enter a hyphen in a telephone number, press **HYPHEN** (One-Touch Dial key 1).

Example: <S02>=1114497

6 Press **START/COPY/SET**.

REGISTERED

↓

PRESS STATION

↑↓

OR USE JOG-DIAL

- To program other stations, repeat steps 2 to 6.

7 Press **STOP** to exit the program.

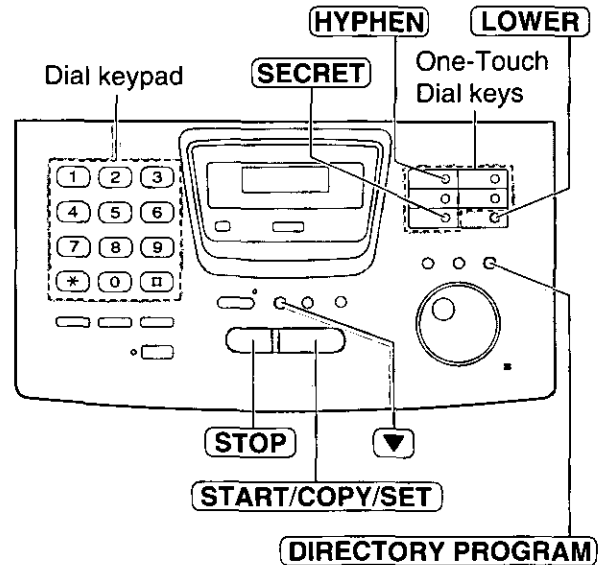

Helpful hints:

- To confirm the stored telephone numbers and station names, print a telephone number list (see page 91).
- The stored names in One-Touch Dial can be searched for using the JOG DIAL directory.

Example: John <S02>

To keep the telephone number secret

Press **SECRET** (One-Touch Dial key 3) after entering the telephone number in step 5.

- You can never view a secret number after this is set.
- The telephone number will not appear on the telephone number list.
- Pressing **SECRET** does not count as a digit.

To edit a stored station name and number

Enter the desired name in step 3.

Enter the desired number in step 5.

To erase a stored station name and number, see page 38.

To select characters with the dial keypad

Pressing the dial keys will select a character as shown below.

Keys		Characters
Dial keys	①	1 [] { } + - / = , . _ ' : ; ?
	②	A B C a b c 2
	③	D E F d e f 3
	④	G H I g h i 4
	⑤	J K L j k l 5
	⑥	M N O m n o 6
	⑦	P Q R S p q r s 7
	⑧	T U V t u v 8
	⑨	W X Y Z w x y z 9
	⑩	0 () < > ! " # \$ % & ¥ * @ ^ ' →
One-Touch Dial keys		HYPHEN key (Used to insert a hyphen.)
		INSERT key (Used to insert one character or one space.)
		SECRET key (Used to keep the telephone number secret.)
Arrow keys		◀ key (Used to move the cursor to the left.)
		▶ key (Used to move the cursor to the right.) To enter another character using the same number key, move the cursor to the next space.

Telephone

Note:

- A hyphen entered in a telephone number is counted as two digits.

To select characters using the JOG DIAL

Instead of pressing the dial keys, you can select characters using the JOG DIAL.

1. Rotate **JOG DIAL** until the desired character is displayed.
2. Press to move the cursor to the next space.
 - The character displayed in step 1 is inserted.
3. Return to step 1 to enter the next character.

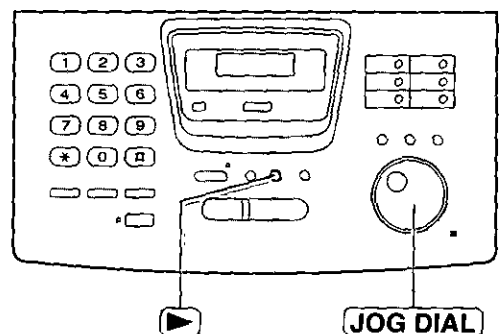

Display order of characters

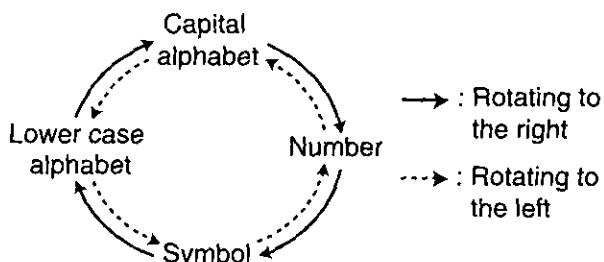

One-Touch Dial

Making a voice call using One-Touch Dial ---

Before using this feature, program the desired names and telephone numbers into One-Touch Dial (see page 34).

- 1 Press **SP-PHONE** or lift the handset.

Display:

- Confirm there are no documents in the document feeder tray.

- 2 **For stations 1–5**
Press the desired One-Touch Dial key.

For stations 6–10
Press **LOWER**, then press the desired One-Touch Dial key.

Example:

- 3 When the other party answers, talk into the microphone or handset.

- 4 When finished, press **SP-PHONE** or hang up the handset.

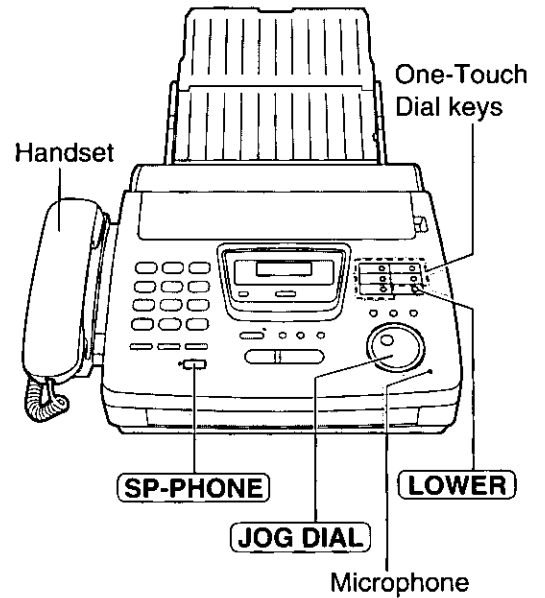

Helpful hints:

- To confirm the items stored in One-Touch Dial, print a telephone number list (see page 91).
- You can use the JOG DIAL directory to select the station name instead of using the One-Touch Dial keys. Rotate **JOG DIAL** until the desired name is displayed, then press **SP-PHONE** or lift the handset.

Storing names and telephone numbers in the JOG DIAL directory

For rapid access to frequently dialed numbers, the unit also provides a JOG DIAL directory (100 stations for KX-FP250, 60 stations for KX-FP245) besides One-Touch Dial. For your convenience, the following 2 stations have been preprogrammed in the JOG DIAL directory.

HELP-FAX (1-800-435-7329): If you cannot correct the problem after trying the help function (see page 15), call using this station (see page 39).

IQ-FAX-CS (IQ-FAX Customer Service Center) (1-888-332-9728): If you have a problem with IQ-FAX, call using this station (see page 39).

If you do not need the above stations, you can edit or erase them (see page 38).

1 Press **DIRECTORY PROGRAM**.

Display:

↑

2 Rotate **JOG DIAL** until the following is displayed.

3 Enter the name, up to 10 characters, by following the instructions on page 35.

Example:

4 Press **START/COPY/SET**.

5 Enter the telephone number up to 30 digits.

Example:

6 Press **START/COPY/SET**.

↓

- To program other items, repeat steps 3 to 6.

7 Press **STOP** to exit the program.

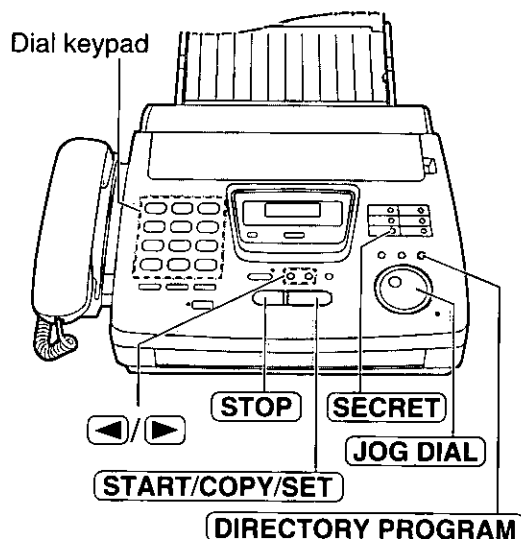

Note:

- To confirm the stored names and telephone numbers, print a telephone number list (see page 91).
- You can store items during a telephone conversation.
- When the following message is displayed in step 6, you can store 5 items only.

Display:

- If the unit shows "JOG-DIAL FULL" in step 1, there is no space to store new stations. Edit or erase unnecessary stations (see page 38).
- By rotating **JOG DIAL** to the right, stored items can be displayed. The order is as follows: alphabet, number, symbol and telephone number (when a name is not stored).

To correct a mistake

- Press **◀** or **▶** to move the cursor to the incorrect character, then make the correction.

To delete a character

- Move the cursor to the character you want to delete and press **STOP**.

To keep the telephone number secret

- Press **SECRET** (One-Touch Dial key 3) after entering the telephone number in step 5.
- You can never view a secret number after this is set.
 - The telephone number will not appear on the telephone number list.
 - Pressing **SECRET** does not count as a digit.

JOG DIAL

Editing a stored name and number

- 1 Rotate **JOG DIAL** until the desired name is displayed.
Example:
- 2 Press **DIRECTORY PROGRAM**.
- 3 Press ***** to select "EDIT".
 - If you do not need to edit the name, skip to step 5.
- 4 Edit the name by following the instructions on page 35.
- 5 Press **START/COPY/SET**.
Example:
 - If you do not need to edit the telephone number, skip to step 7.
- 6 Edit the telephone number. For further details, see page 37.
- 7 Press **START/COPY/SET**.

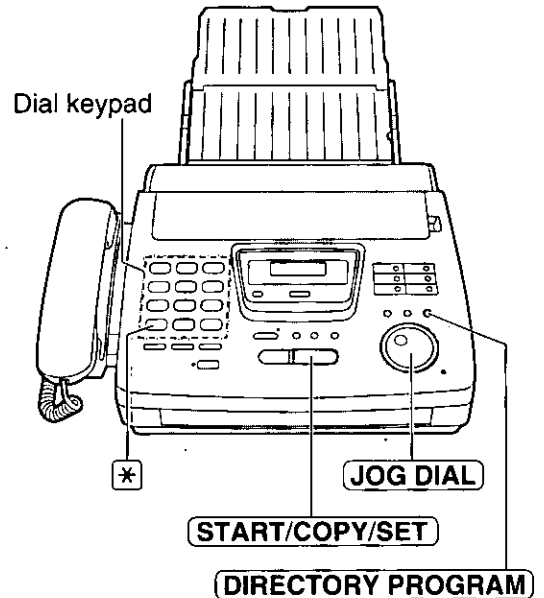

Erasing a stored name and number

You can also erase a name and number stored for One-Touch Dial by following the instructions below.

- 1 Rotate **JOG DIAL** until the desired name is displayed.
Example:
- 2 Press **DIRECTORY PROGRAM**.
- 3 Press **□** to select "DELETE".

↓
 - If you do not want to erase the item, press **STOP**.
- 4 Press **START/COPY/SET**.
 - The stored name and number are deleted.

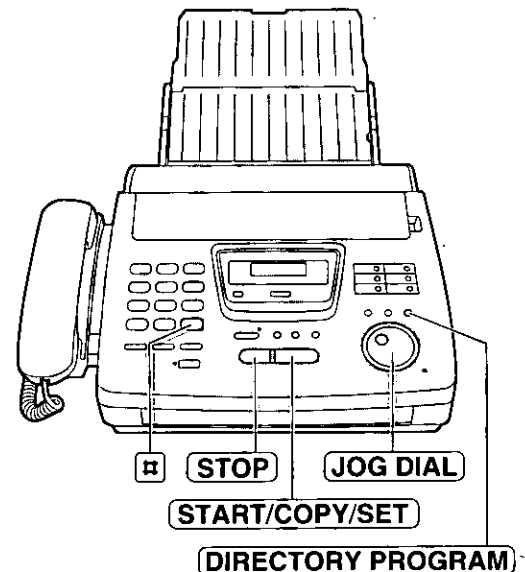

Making a voice call using the JOG DIAL directory ==

Before using this feature, program the desired names and telephone numbers into the directory (see page 37).

- 1 Rotate **JOG DIAL** until the desired name is displayed.
Example:
- 2 Press **SP-PHONE** or lift the handset.
 - The unit will start dialing automatically.
- 3 When the other party answers, talk into the microphone or the handset.
- 4 When finished, press **SP-PHONE** or hang up the handset.

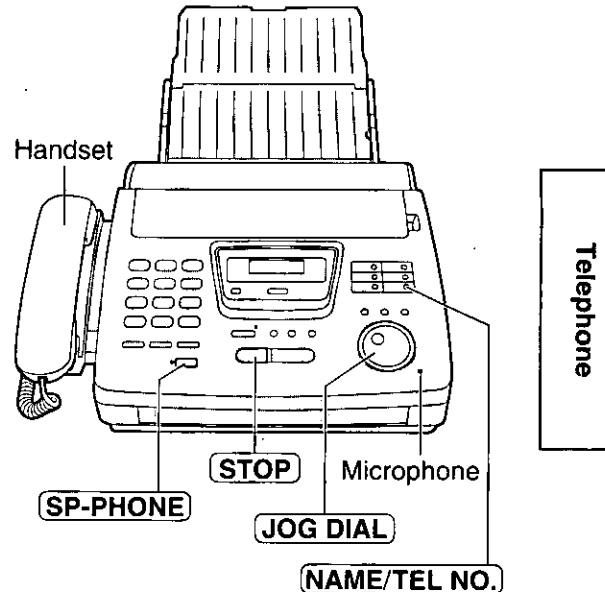

Helpful hint:

- To confirm the items stored in the directory, print a telephone number list (see page 91).

Note:

- If the desired name has not been stored, press **STOP** and dial the number manually. To store the name and number, see page 37.

To search for a name by the initial

Example: When you want to search for the name "Lisa"

1. Rotate **JOG DIAL** until any name is displayed.
Example:
 2. Press **5** repeatedly until any name with the initial "L" is displayed (see the character table on page 35).
 3. Rotate **JOG DIAL** to the right until "Lisa" is displayed.
- To stop the operation, press **STOP**.
4. Press **SP-PHONE** or lift the handset, and the unit will automatically dial the number.

To confirm a stored telephone number

1. Rotate **JOG DIAL** until the desired name is displayed.

Example:

2. Press **NAME/TEL NO.**.
- To stop the operation, press **STOP**.
3. Press **SP-PHONE** or lift the handset, and the unit will automatically dial the number.

Voice Contact

Talking to the caller after fax transmission or reception

You can have a conversation during the same call after the fax message is completed. This will save the added expense and time of making another call.

This feature only works when the other party's fax machine is equipped with a voice contact feature.

Initiating voice contact

- 1 Press **SP-PHONE** while transmitting or receiving documents.

Display: VOICE STANDBY

- Your unit will call the other party with a distinctive ring.
- When the other party answers, your unit will emit a distinctive ring.

- 2 Press **SP-PHONE** or lift the handset to start talking.

Note:

- If you initiate voice contact during transmission, the unit will call you with a distinctive ring after all of the documents have been transmitted.
- If you initiate voice contact during reception, the unit will call you with a distinctive ring after the current page of the document is received.

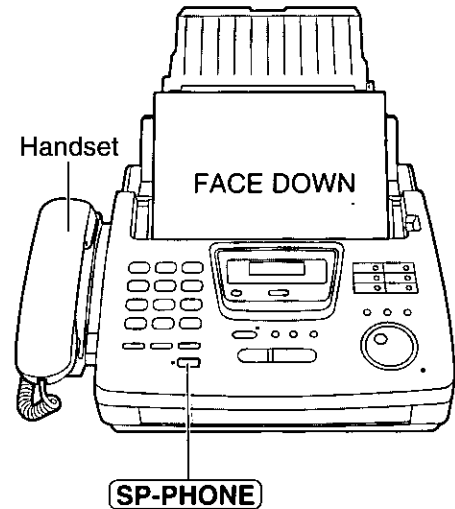

Receiving a request for voice contact

- 1 If the other party answers, your unit will sound a distinctive ring and the following will be displayed.

Display: PLEASE PICK UP

- 2 Press **SP-PHONE** or lift the handset within 10 seconds of the distinctive ring to start talking.

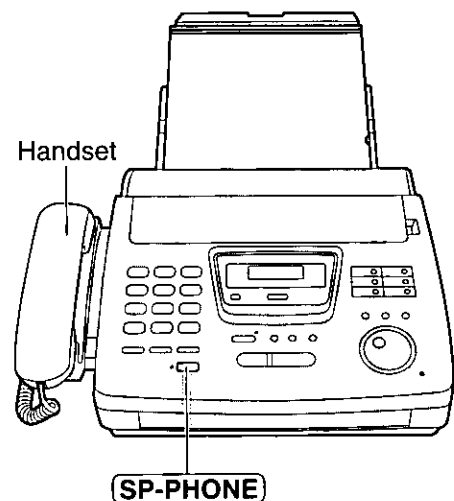

Sending a fax manually

- 1 Open the document feeder tray.
- 2 Adjust the width of the document guides to the size of the document.
- 3 Insert the document (up to 15 pages) **FACE DOWN** until a single beep is heard and the unit grabs the document.

Display: STANDARD

- 4 If necessary, press **RESOLUTION** repeatedly to select the desired setting (see the bottom of this page).

- 5 Press **SP-PHONE** or lift the handset.

TEL=

- 6 Dial the fax number.

Example: TEL=5678901

- 7 **When a fax tone is heard:**
Press **START/COPY/SET**, and hang up the handset if using it.

OR

When the other party answers your call:

Ask them to press their start button. When a fax tone is heard, press your **START/COPY/SET** and hang up the handset if using it.

CONNECTING.....

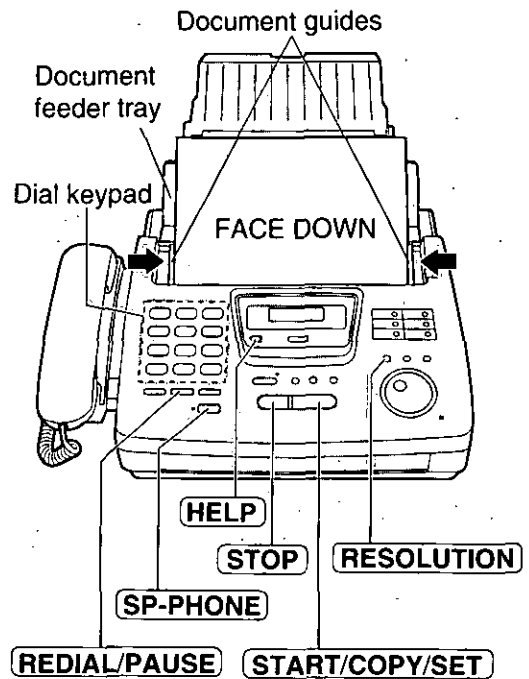

Note:

- If you cannot send a fax, confirm the problem by printing a journal report (see page 91) and try to solve the problem (see page 78).

To feed more than 15 pages at a time

Insert the first 15 pages of the document. Add the extra pages (up to 15) before the last page is fed into the unit.

To redial the last number

Press **REDIAL/PAUSE**.

- If the line is busy, the unit will automatically redial the number up to 5 times.
- During redial, the following will be displayed.

Display: WAITING REDIAL.

To stop transmission

Press **STOP**.

To eject the document, press **STOP** again.

To select the resolution

Select the desired resolution according to the type of document.

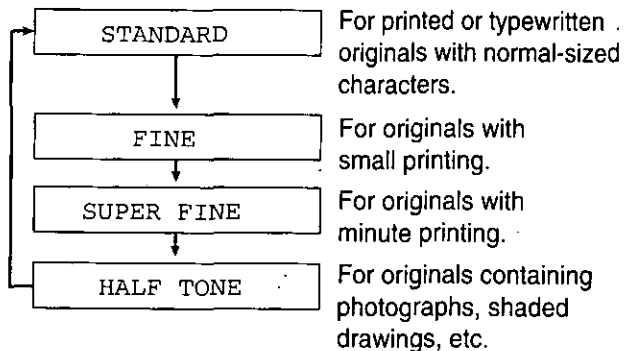

- Using the fine, super fine or half tone setting will increase the transmission time.
- If the resolution setting is changed during feeding, it will be effective from the next sheet.
- The super fine resolution only works with other compatible fax machines.

Sending Faxes

Sending a fax using One-Touch Dial

Before using this feature, program the desired names and telephone numbers into One-Touch Dial (see page 34).

- 1 Open the document feeder tray.
- 2 Adjust the width of the document guides to the size of the document.
- 3 Insert the document (up to 15 pages) **FACE DOWN** until a single beep is heard and the unit grabs the document.

Display:

- 4 If necessary, press **RESOLUTION** repeatedly to select the desired setting (see the bottom of page 41).

- 5 **For stations 1–5**
Press the desired One-Touch Dial key.
For stations 6–10
Press **LOWER**, then press the desired One-Touch Dial key.

Example:

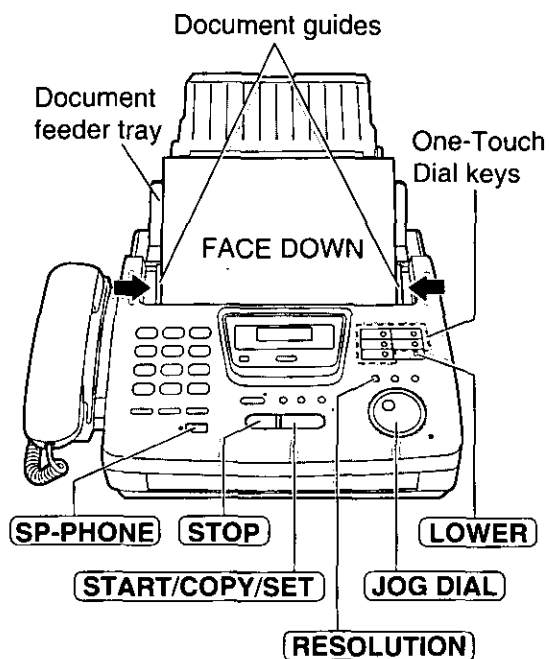

Helpful hints:

- To confirm the items stored in One-Touch Dial, print a telephone number list (see page 91).
- You can use the JOG DIAL directory to select the station name instead of using the One-Touch Dial keys. Rotate **JOG DIAL** until the desired name is displayed, then press **START/COPY/SET**.
- The connecting tone will be heard during dialing to tell you the status of the other party's machine (see page 55).

Note:

- If your fax does not transmit, press **SP-PHONE** and then repeat step 5. Verify that the number dialed is answered by the other party's fax machine.

Fax auto redial

If the line is busy or there is no answer, the unit will automatically redial the number up to 5 times.

- This feature is also available for;
 - sending faxes using the JOG DIAL directory (page 43), and
 - delayed transmission (page 50).
- During redial, the following will be displayed.

Display:

- To cancel redialing, press **STOP**.

Sending a fax using the JOG DIAL directory

Before using this feature, program the desired names and telephone numbers into the directory (see page 37).

- 1 Open the document feeder tray.
- 2 Adjust the width of the document guides to the size of the document.
- 3 Insert the document (up to 15 pages) **FACE DOWN** until a single beep is heard and the unit grabs the document.

Display:

- 4 If necessary, press **RESOLUTION** repeatedly to select the desired setting (see the bottom of page 41).

- 5 Rotate **JOG DIAL** until the desired name is displayed.

Example:

- To confirm the number, press **NAME/TEL NO.**

- 6 Press **START/COPY/SET**:

Example:



- The unit will start transmission.

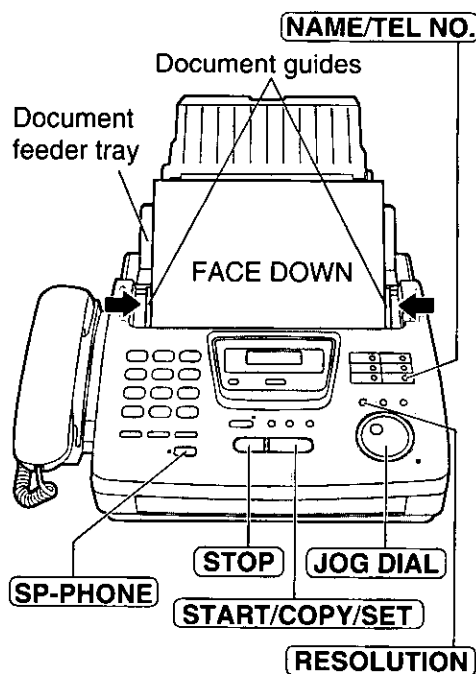

Helpful hints:

- To confirm the items stored in the directory, print a telephone number list (see page 91).
- The connecting tone will be heard during dialing to tell you the status of the other party's machine (see page 55).

Note:

- If the desired name has not been stored, press **STOP** and dial the number manually.
To store the name and number, see page 37.
- For further details about using the JOG DIAL, see page 39.
- If your fax does not transmit, press **SP-PHONE** and then repeat steps 5 and 6. Verify that the number dialed is answered by the other party's fax machine.

Sending Faxes

IQ-FAX

This feature can only be used by those who apply to the FaxSav service.

IQ-FAX is intelligent faxing which allows you to send faxes via the internet by using the IQ-FAX button. Behind the IQ-FAX button is the FaxSav Global Fax Network which manages the delivery of your fax to any fax machine in the world. It routes your fax via the best and most time efficient route and will automatically resend your fax for you, if the receiving fax machine is unavailable.

This "fax-only" network has the added advantage of cost efficiency due to the internet being integrated into the network. Every fax is secure since the FaxSav network utilizes the highest encryption legally allowed, ensuring that your documents stay secure. You get the benefits of carefree faxing with savings associated with the use of the internet. It is simple, quick, and secure.

For more information, contact FaxSav at 1-888-332-9728. This number is pre-programmed in the JOG DIAL directory (see page 37).

How your fax is sent to the other party's fax machine

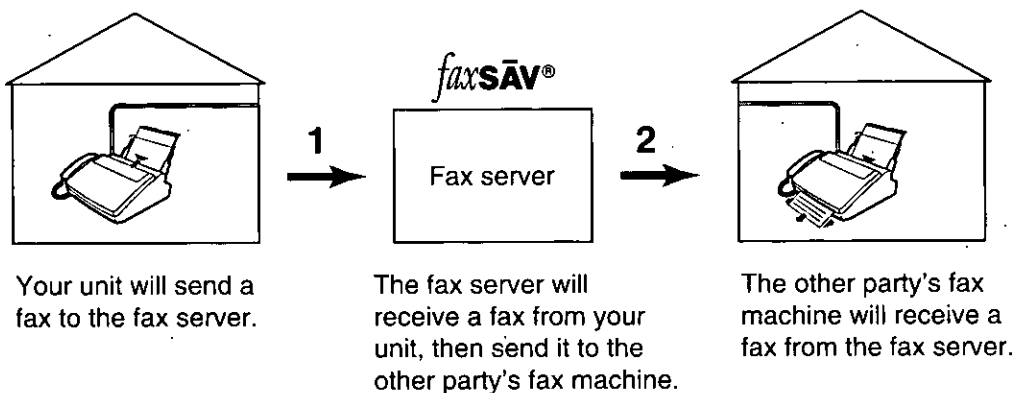

- 1 If any transmission errors occur between your unit and the fax server, your unit will automatically redial to the fax server up to 2 times.
- 2 If any transmission errors occur between the fax server and the other party's fax machine, the fax server will automatically redial to the other party's fax machine up to 4 times. If your fax is still not transmitted after 4 attempts, the fax server will fax a Non-Delivery Notice to you. In this case, there is no charge to you. Set your unit to receive a fax.

How to apply for the FaxSav Internet service for your unit

- 1 Fill out the attached application form and fax it to 1-800-909-6649.
 - The FaxSav company will send you a welcome fax after they have activated your account.
 - There is no application or monthly fee. You pay only for the faxes you send.
- 2 To enable the IQ-FAX function from your fax machine, set feature setting #75 to ON (see page 45).

Turning on the IQ-FAX function

Before programming, confirm that your application has been processed by FaxSav.

- 1 Press **MENU**.
Display: 1. SYSTEM SET UP
- 2 Press **□**, then **7 5**.
IQ-FAX
- 3 Press **START/COPY/SET**.
MODE=OFF ▼▲
- 4 Press ▼ or ▲ to select "ON".
MODE=ON ▼▲
 - If this feature is not required, select "OFF".
- 5 Press **START/COPY/SET**.
SETUP ITEM []
- 6 Press **MENU**.

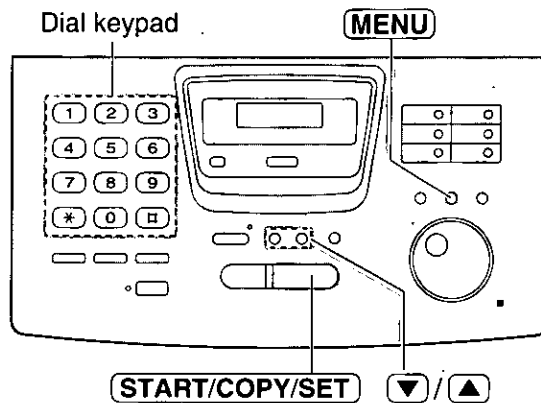

Sending Faxes

Sending a fax using the Internet

- 1 Open the document feeder tray.
- 2 Adjust the width of the document guides to the size of the document.
- 3 Insert the document (up to 15 pages) **FACE DOWN** until a single beep is heard and the unit grabs the document.

Display:

- 4 If necessary, press **RESOLUTION** repeatedly to select the desired setting (see the bottom of page 41).

- 5 Press **IQ-FAX**.

- 6 Dial the fax number.

- 7 Press **START/COPY/SET**.



- If the number you dialed is out of the FaxSav network service area, the unit will show the following messages and send the fax directly over the telephone line.



- If "OUT OF NETWORK" is displayed when sending a fax long distance or internationally when using IQ-FAX, then contact FaxSav at 1-888-332-9728.

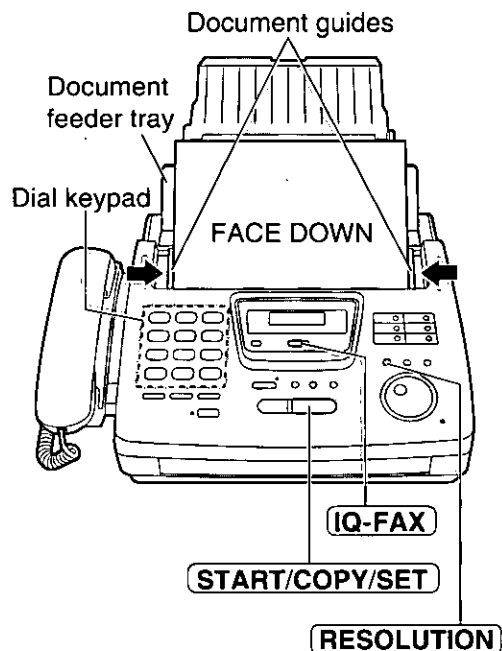

If you cannot send a fax

Contact FaxSav at 1-888-332-9728.

The FaxSav customer service center may send you a program update. While receiving this update, you will not be able to operate the unit and the following message will be displayed for about 3 minutes. During this time, you also will not be able to operate extension telephones, if they are connected.

Display:

If a loading error occurs, the unit will display the following message.

In this case, contact FaxSav at 1-888-332-9728.

Documents you can send

Minimum size

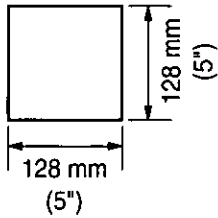

Maximum size

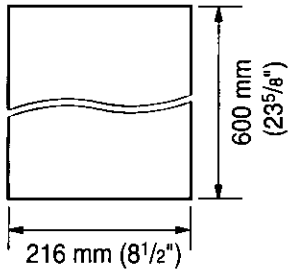

Effective scanning area

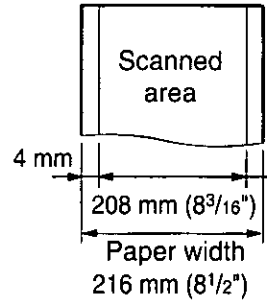

Document weight

Single sheet:
45 g/m² to 90 g/m²
(12 lb. to 24 lb.)

Multiple sheets:
60 g/m² to 75 g/m²
(16 lb. to 20 lb.)

Note:

- Remove clips, staples or other similar fastening objects.
- Check that ink, paste or correction fluid has dried.
- Do not send the following types of documents. Use copies for fax transmission.
 - Chemically treated paper such as carbon or carbonless duplicating paper
 - Electrostatically charged paper
 - Heavily curled, creased or torn paper
 - Paper with a coated surface
 - Paper with a faint image
 - Paper with printing on the opposite side that can be seen through the front (e.g. newspaper)

Fax/Copy

Sending Faxes

Confirmation report

The sending report will provide you with a printed record of the fax transmission result. One of the following choices is available.

- ERROR:** The sending report will print out only when fax transmission fails (pre-selected setting).
- ON:** The sending report will always print out, indicating whether fax transmission is successful or not.
- OFF:** The sending report will not print.

- 1 Press **MENU**.
Display: 1.SYSTEM SET UP
- 2 Press **□**, then **0 4**.
SENDING REPORT
- 3 Press **START/COPY/SET**.
MODE=ERROR ▼▲
- 4 Press ▼ or ▲ to select the desired setting.
- 5 Press **START/COPY/SET**.
SETUP ITEM []
- 6 Press **MENU**.

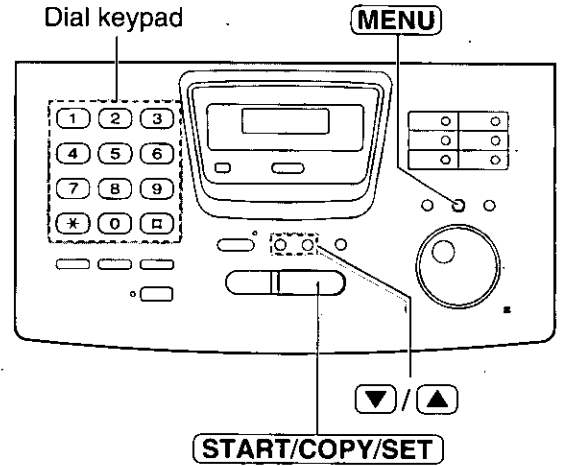

Sample of a sending report

SENDING REPORT								Jan. 20 1998 01:19PM
NO.	OTHER FACSIMILE	START TIME	USAGE TIME	MODE	PAGES	RESULT	*CODE	
01	2345678	Jan. 20 01:18PM	00'51	SND	00	COMMUNICATION ERROR	(43)	

SND: Sent directly.
IQ-FAX: Sent to the fax server.

Communication message
(See page 78.)

Error code
(for service personnel use only)

Note:

- If your fax is not transmitted to the other party's fax machine using the FaxSav network, the FaxSav network will send a Non-Delivery Notice to your unit.

Automatic journal report printing

This feature prints a journal report automatically after every 35 new fax communications. After printing, only the oldest communication result will be erased when a new communication occurs. When this feature is deactivated, the unit will store the records of the fax communications, but will not print the journal report automatically.

- 1 Press **MENU**.
 Display: 1.SYSTEM SET UP
- 2 Press **2**, then **2**.
AUTO JOURNAL
- 3 Press **START/COPY/SET**.
MODE=ON ▼▲
- 4 Press ▼ or ▲ to select the desired setting.
 • If this feature is not required, select "OFF".
- 5 Press **START/COPY/SET**.
SETUP ITEM []
- 6 Press **MENU**.

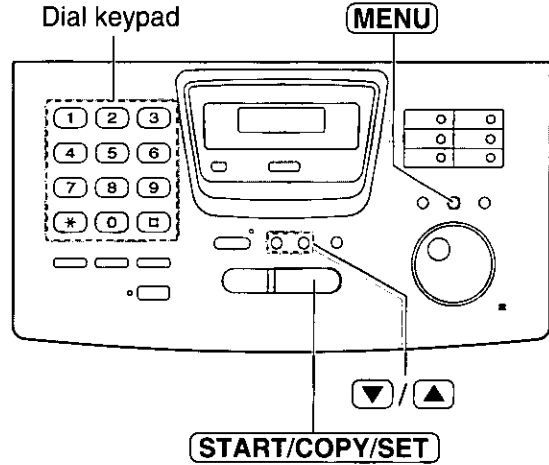

Fax/Copy

Sample of a journal report

JOURNAL									
Jan. 25 1998 05:22PM									
NO.	OTHER FACSIMILE	START TIME	USAGE TIME	MODE	PAGES	RESULT	*CODE		
01	3332222	Jan. 21 02:14PM	00'45	SND	01	OK			
02	9998765	Jan. 21 03:17PM	00'58	IQ-FAX	02	OK			
03	John	Jan. 21 05:18PM	00'48	RCV	01	OK			
04	555556677	Jan. 22 10:35AM	02'45	SND	03	COMMUNICATION ERROR	(43)		
05			02'50	SND	05	OK			
06				RCV	03	OK			

SND: Sent directly.
 IQ-FAX: Sent to the fax server.
 RCV: Received directly.

Communication message
 (See page 78.)

Error code
 (for service personnel use only)

Note:

- If your fax is not transmitted to the other party's fax machine using the FaxSav network, the FaxSav network will send a Non-Delivery Notice to your unit.

Sending Faxes

Delayed transmission (sending a fax at a specific time)

Using a built-in clock, this unit can send documents automatically at a specific time. This allows you to take advantage of low-cost calling hours offered by your telephone company. The delayed transmission can be reserved to take place up to 24 hours in advance.

- 1 Insert the document **FACE DOWN**.
Display: STANDARD
- 2 Press **MENU**.
1. SYSTEM SET UP
- 3 Press **[FAX]**, then **[2]** **[5]**.
DELAYED SEND
- 4 Press **START/COPY/SET**.
MODE=OFF ▼▲
- 5 Press ▼ or ▲ to select "ON".
MODE=ON ▼▲
- 6 Press **START/COPY/SET**.
FAX=
- 7 Enter the fax number using the dial keypad, One-Touch Dial or **JOG DIAL**.
- 8 Press **START/COPY/SET**.
TIME=12:00AM
- 9 Enter the transmission start time.
Example (using the dial keypad): 11:30PM
Press **[1]** **[1]** **[3]** **[0]**, then press **[*]** to select "PM".
TIME=11:30PM
 - To select "AM", press **[*]** until "AM" is displayed.
- 10 Press **START/COPY/SET**.
SETUP ITEM []
- 11 Press **MENU**.
SEND AT 11:30PM
 - When the programmed time arrives, the unit will automatically start transmission.

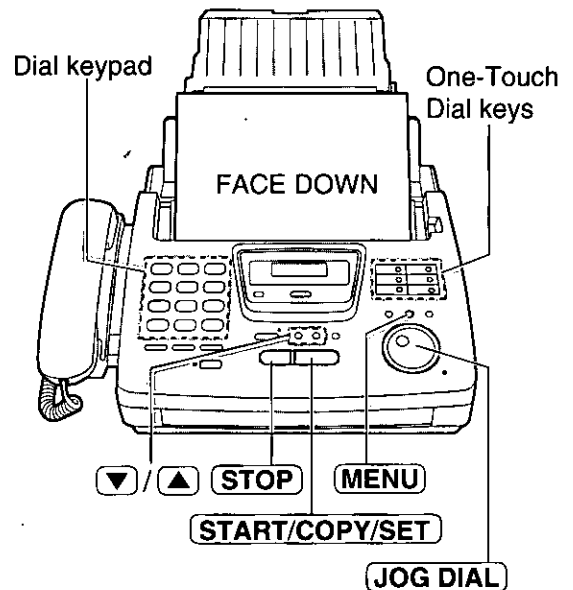

Note:

- You can receive, transmit and copy documents while delayed transmission is set.

To cancel the delayed transmission setting

1. Press **STOP** while the unit is idle.

Display: SEND CANCELED?



YES: PRESS SET

2. Press **START/COPY/SET**.

From memory

The unit is able to scan and store documents into memory, and then transmit the stored documents. The memory capacity is approx. 25 pages based on the CCITT No. 1 test chart in standard resolution. For the CCITT No. 1 test chart, see page 97.

Setting memory transmission

- 1 Press **MENU**.
Display: 1. SYSTEM SET UP
- 2 Press **□**, then **1 5**.
SEND BY MEMORY
- 3 Press **START/COPY/SET**.
MODE=OFF ▼▲
- 4 Press ▼ or ▲ to select "ON".
MODE=ON ▼▲
 - If this feature is not required, select "OFF".
- 5 Press **START/COPY/SET**.
SETUP ITEM []
- 6 Press **MENU**.

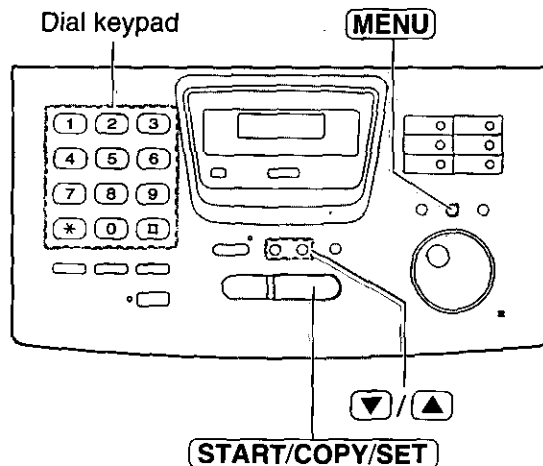

Fax/Copy

Transmitting documents from memory

- 1 Insert the document FACE DOWN.
- 2 Enter the fax number using the dial keypad, One-Touch Dial or **JOG DIAL**.
- 3 When using the dial keypad or **JOG DIAL**, press **START/COPY/SET**.
 - The document will be fed into the unit and scanned into memory. After storing all of the pages, the unit will transmit the documents.
 - The amount of memory used will be shown as a percentage on the display.

Display: PAGES=01 05
Amount of memory used

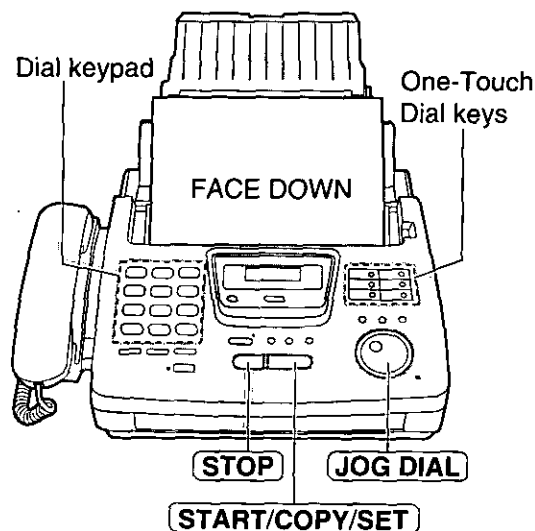

Note:

- The stored documents will be automatically erased after transmission.
- To cancel the memory transmission, press **STOP** during or after scanning the document.
- If you select the fine, super fine or half tone resolution, the number of documents that can be sent will decrease.
- If the stored pages exceed the memory capacity, the transmission will be canceled.

Sending Faxes

Multiple stations

This feature is useful when frequently sending the same documents to selected parties whose telephone numbers are stored in One-Touch Dial and the JOG DIAL directory. You must program the desired parties into the BROADCAST key (One-Touch Dial key 1).

Important:

- Before programming, make sure that the desired telephone numbers have been stored into One-Touch Dial or the JOG DIAL directory.
- The BROADCAST key can be used as One-Touch Dial key 1 or as the broadcast key.

Programming the BROADCAST key with telephone numbers

1 Press **DIRECTORY PROGRAM**.

Display:
↓

2 Press **BROADCAST**.

▼▲

3 Press ▼ or ▲ to select "BROADCAST".

▼▲

4 Press **START/COPY/SET**.

5 Enter the stations.

a: Using One-Touch Dial:

For stations 2-5, press the preset One-Touch Dial key.

For stations 6-10, press **LOWER**, then press the preset One-Touch Dial key.

Example:

b: Using JOG DIAL directory:

Rotate **JOG DIAL** until the desired name is displayed (up to 100 stations for KX-FP250, 60 stations for KX-FP245).

Example:

Press **START/COPY/SET**.

Example:

- To enter other stations, repeat this step (up to 109 stations for KX-FP250, 69 stations for KX-FP245).

6 Press **START/COPY/SET** after entering all of the desired stations.

7 Press **STOP** to exit the program.

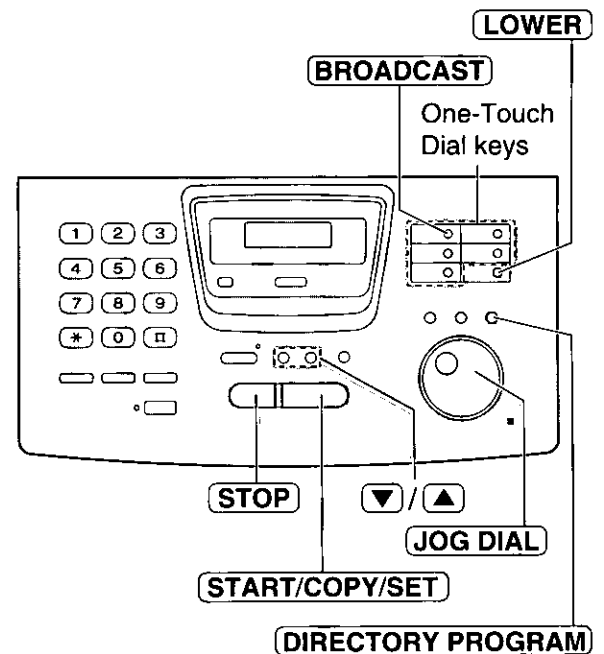

Note:

- If you make a mistake while programming, press **STOP**, then make the correction.
- Confirm the stored numbers by printing a telephone number list (see page 91).

Using the BROADCAST key

The documents will be scanned and stored into memory when using the BROADCAST key. After transmission, the stored documents will be erased automatically.

The memory capacity is approx. 25 pages based on the CCITT No. 1 test chart in standard resolution. For the CCITT No. 1 test chart, see page 97.

- 1** Insert the document FACE DOWN.
- 2** Press **BROADCAST**.
 - The documents will be fed into the unit and scanned into memory. Then the unit will transmit the data to each station, calling each number sequentially.

Note:

- If you select the fine, super fine or half tone resolution, the number of pages that the unit can transmit will decrease.
- If one of the stations is busy or does not answer, the station will be skipped. All skipped stations will be redialed up to 5 times after all of the other stations have been called.



To cancel the broadcast setting

1. Press **STOP** while the unit is idle.

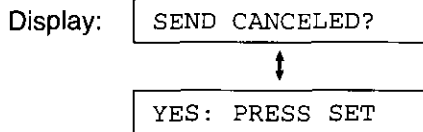

2. Press **START/COPY/SET**.

Broadcast report

After all of the transmissions have been completed, the unit will automatically print the following report.

Sample of a broadcast report:

BROADCAST REPORT						(1/1)
						Jan. 10 1998 03:36PM
NO.	OTHER FACSIMILE	START TIME	USAGE TIME	PAGES (IQ-FAX)	RESULT	
001	Mike	Jan. 10 03:31PM	01'10	02	* OK	
002	Peter	Jan. 10 03:33PM	01'08	02	OK	
003	Sam	Jan. 10 03:34PM	01'09	02	OK	
004	Kim	Jan. 10 03:35PM	01'10	02	OK	
TOTAL			004'37	008	(002)	

Total number of pages sent to the fax server.

The "*" mark in this column shows the fax has been sent to the fax server.

Sending Faxes

Overseas

You may experience difficulty when transmitting documents overseas. This feature makes sending documents easier as the transmission speed is slowed down. Before starting transmission, follow the steps below.

- 1 Press **MENU**.
Display: 1.SYSTEM SET UP
- 2 Press **☐**, then **2 3**.
OVERSEAS MODE
- 3 Press **START/COPY/SET**.
MODE=OFF ▼▲
- 4 Press ▼ or ▲ to select "ON".
MODE=ON ▼▲
● If this feature is not required, select "OFF".
- 5 Press **START/COPY/SET**.
SETUP ITEM []
- 6 Press **MENU**.

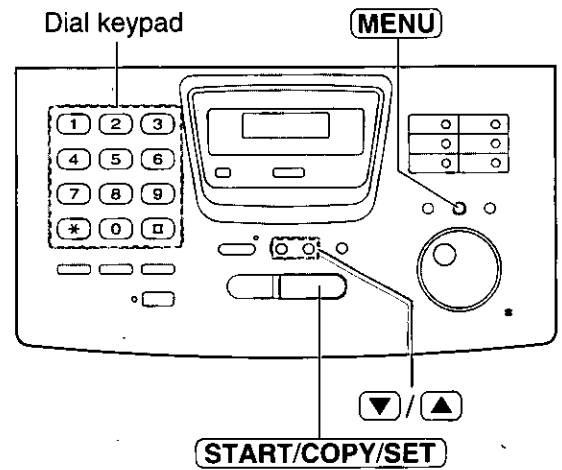

Note:

- After transmission, this feature will turn off automatically.
- This feature is not available for transmission using the BROADCAST key.
- The calling charges will be higher when using this feature.

Connecting tone

This feature allows you to hear connecting tones, such as a fax tone, ring back tone or busy tone for several seconds when you send a fax using One-Touch Dial or the JOG DIAL directory. This will tell you the status of the other party's machine.

If you hear a:

- Fax tone: The other party's machine is ready for reception.
- Ring back tone: If this tone continues, the other party's machine may not be a facsimile or ran out of paper. Check with the other party.
- Busy tone: The other party's machine is busy. Press **STOP** and try again later.

If this feature is not required, turn it off.

- 1 Press **MENU**.
Display: 1.SYSTEM SET UP
- 2 Press **□**, then **7** **6**.
CONNECTING TONE
- 3 Press **START/COPY/SET**.
MODE=ON ▼▲
- 4 Press ▼ or ▲ to select the desired setting.
● If this feature is not required, select "OFF".
- 5 Press **START/COPY/SET**.
SETUP ITEM []
- 6 Press **MENU**.

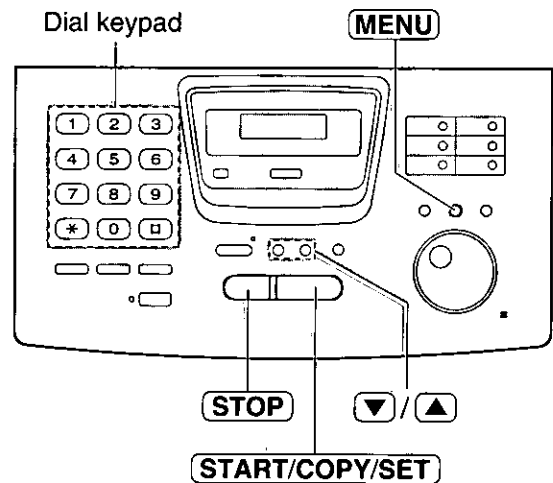

Note:

- The connecting tone volume cannot be adjusted.

Receiving Faxes

Setting the unit to receive calls

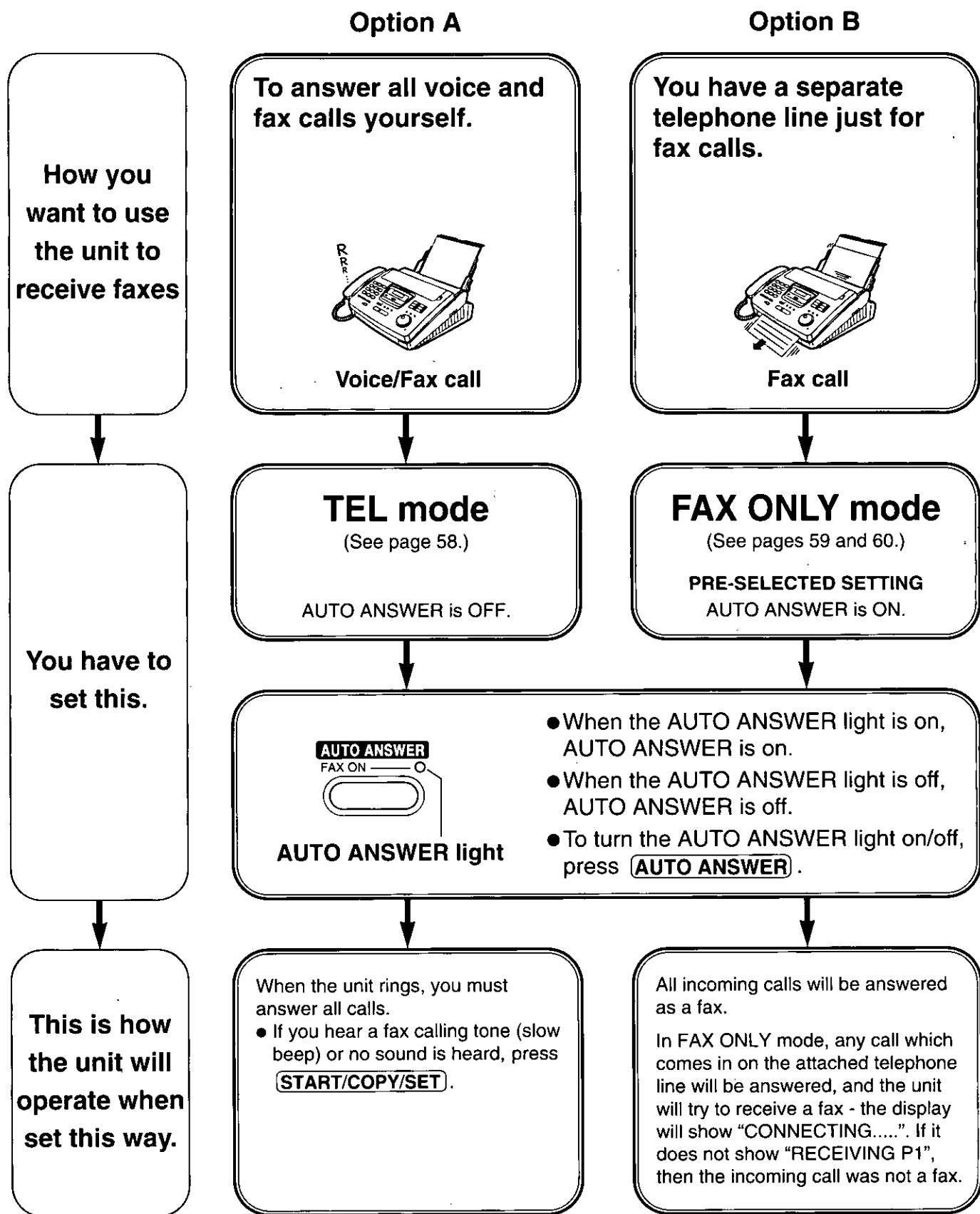

Option C

You have Distinctive Ring service from the telephone company (this allows you to have up to 3 telephone numbers on the same line).

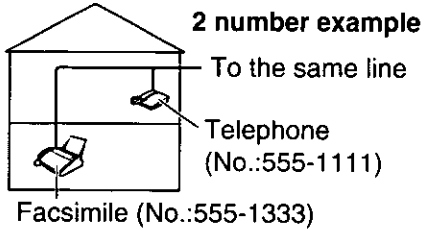

To activate the Distinctive Ring mode, select the same ring pattern as assigned to the facsimile number in feature #31 (see pages 64 and 65):

- A:** Standard ring (one long ring)
- B:** Double ring (two short rings)
- C:** Triple ring (short-long-short rings)
- D:** Other triple ring (short-short-long rings)

The unit will automatically answer calls which come in on your facsimile number. If a call comes in on the other telephone number, the unit will operate based on the receive mode you have set.

Option D

You want to use the fax machine with an answering machine.

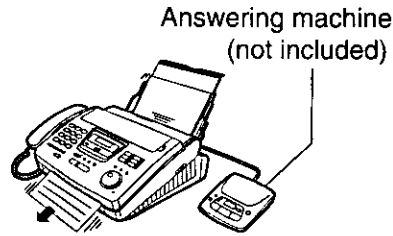

Voice/Fax call

1. Connect an answering machine to the EXT jack.
2. Set the number of rings on the answering machine to less than 4.
3. Record a greeting message to the answering machine.
4. Turn on the answering machine.
5. Program the remote activation ID into your fax machine.

For further details, see pages 61 to 63.

Use with option A or B.
If you use with option B, set the FAX ONLY mode ring count to "5 EXT.TAM" (see page 60).

When receiving voice calls:
The answering machine will record voice messages.

When receiving fax calls:
The fax machine will receive documents.

Other options

If you have a voice mail service from your telephone company, you also need to subscribe to a Distinctive Ring service. See pages 64 and 65.

If you have a computer attached to the same telephone line, see page 62.

If you are near the unit and want to use it to receive all of your voice and fax calls, see pages 66 to 69.

If you answer a telephone in another room and hear a fax being received, you can activate the unit remotely by pressing *9. See page 70.

Receiving Faxes

TEL mode (answering all calls manually)

Turn off the AUTO ANSWER mode by pressing **AUTO ANSWER** until the AUTO ANSWER light turns off.

- The display will show the following.

Display: TEL MODE

1 When the unit rings, press **SP-PHONE** or lift the handset to answer the call.

2 When:
— document reception is required,
— a fax calling tone (slow beep) is heard, or
— no sound is heard,
press **START/COPY/SET**.

CONNECTING.....

3 Hang up the handset, if using it.
• The unit will start reception.

Note:

- If you do not answer the call within 15 rings, the unit will temporarily switch to the fax and the caller can send documents.

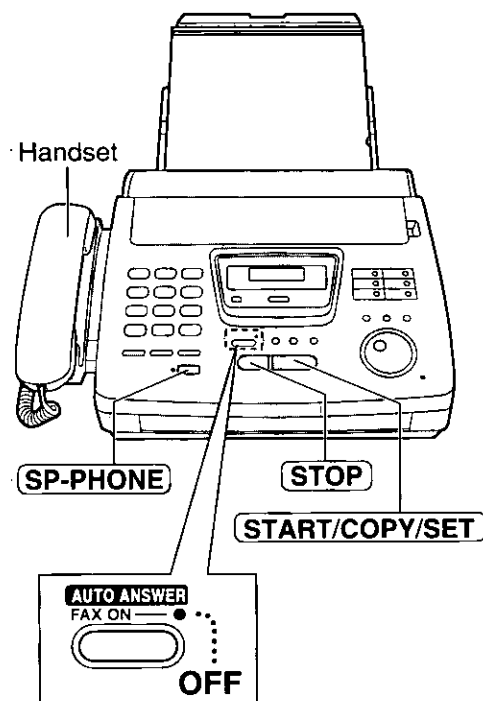

To stop receiving

Press **STOP**.

Friendly reception feature

When you answer a call and hear a fax calling tone (slow beep), the unit will automatically start receiving even if you do not press **START/COPY/SET**.

- If this feature is not required, set to "OFF" (see page 73).

Memory reception

When a printing problem is detected, the unit will temporarily store the received document into memory.

While documents are in memory, the unit will:
— display an error message and the following message alternately;

Display: FAX IN MEMORY

- alert you with a slow beep (Receive alert).
- Follow the instructions on pages 79 and 80 to solve the problem and print the stored document.
- For memory capacity, see page 97.

FAX ONLY mode

(all calls are received as faxes)

Activating the FAX ONLY mode

Turn on the AUTO ANSWER mode by pressing **AUTO ANSWER** until the AUTO ANSWER light turns on.

- The display will show the following.

Display: FAX ONLY MODE

- The unit will automatically answer all calls and only receive fax documents.
- The number of rings before a call is answered can be changed (see page 60).

Note:

- This mode should not be used on a telephone line which is used for both voice and fax calls. When the unit answers the call, fax communication is attempted with the other fax machine even if someone is trying to call you.

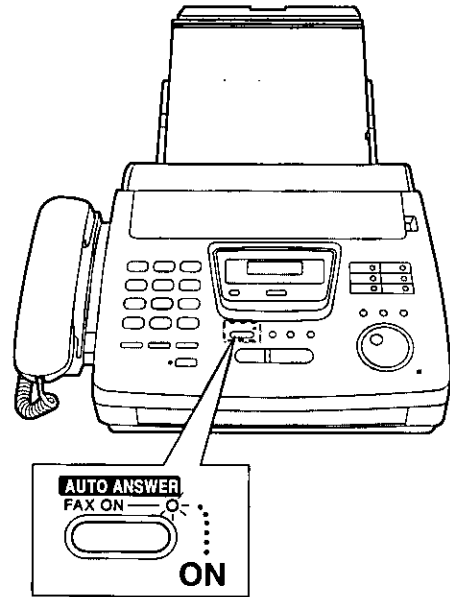

Fax/Copy

If you have a telephone line just for receiving faxes, we recommend the following setup.

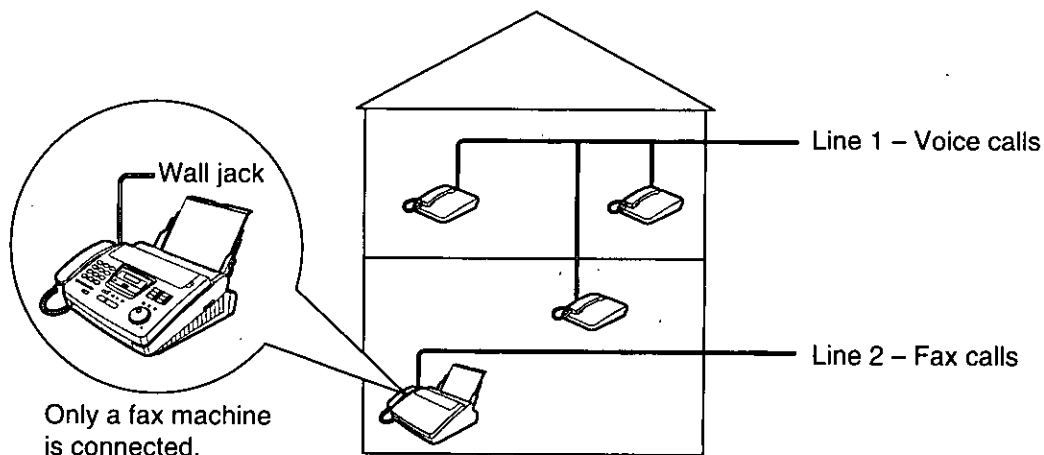

Example: A telephone line is used for voice calls and a separate telephone line for the fax machine. Therefore, two telephone lines are used. When someone is sending a fax, the fax machine will ring once (see page 60).

Receiving Faxes

Setting the FAX ONLY mode ring count

This setting determines the number of rings before the unit answers a call in the FAX ONLY mode. You can choose from 1 to 5 rings. If you use the unit with an answering machine, select "5 EXT.TAM" (see pages 60 to 63).

Helpful hints:

- To answer a call before the unit does, increase the number of rings.
- If you have difficulty receiving faxes, the other parties may have tried to send faxes before confirming if your unit answered. Decrease the number of rings.

- 1 Press **MENU**.
Display: 1.SYSTEM SET UP
- 2 Press **Ⓜ**, then **0 7**.
FAX RING COUNT
- 3 Press **START/COPY/SET**.
RING=1 ▼▲
- 4 Press ▼ or ▲ to select the desired number or enter the desired number using the dial keypad.
- 5 Press **START/COPY/SET**.
SETUP ITEM []
- 6 Press **MENU**.

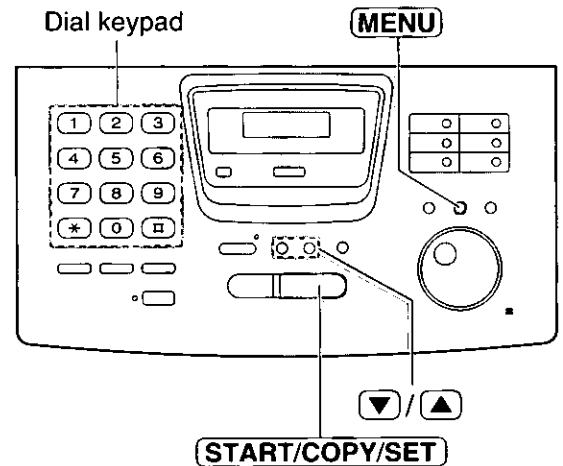

Using with an answering machine

Connecting an answering machine

Connect the answering machine to the EXT jack.

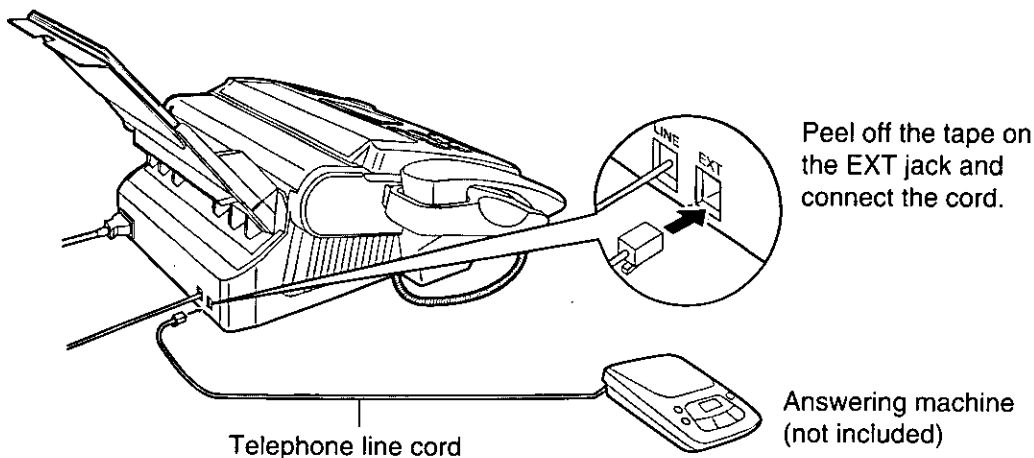

Fax/Copy

How the unit and answering machine work

Receiving voice calls

The answering machine will record voice messages automatically.

Receiving fax calls

The fax machine will receive documents automatically.

Receiving a voice message and fax document in one call

The answering machine will record the voice message first. Then, the fax machine will be activated by the caller's request and receive the document. For further details, see page 63.

Important:

- If you set the **TEL/FAX** mode, you cannot use an answering machine.
- When you set the **FAX ONLY** mode, set the **FAX ONLY** mode ring count to "5 EXT.TAM" (see page 60) and confirm that the number of rings on the answering machine is less than 4. The number of rings on the answering machine should be less than the **FAX ONLY** mode ring count so that the answering machine will answer a call first.

Receiving Faxes

Activating the answering machine

- 1 Set the number of rings on the answering machine to less than 4.
 - This will allow the answering machine to answer the call first.
- 2 Record a greeting message in the answering machine.

Example: *"This is (your name, business and/or telephone number). We are unable to answer the phone right now. Please leave a message after the long beep. To send a fax, start transmission. Thank you."*
- 3 Turn on the answering machine.

Note:

- Do not pause for 4 seconds or more during the greeting message. If a 4 second pause is stored in the greeting message, all incoming calls will be routed to the unit from the answering machine even while the greeting message is playing.
- We recommend you keep the greeting message around 10 seconds long. If the greeting message is too long, some incoming fax calls may not be answered by the fax machine.
- **If your answering machine is equipped with a remote operation feature, set the same remote access code that is on the answering machine to the fax machine (see page 63).**
- If the answering machine is not turned on, all incoming calls will be answered by the fax machine and callers cannot leave voice messages.
- Every time the unit receives a document, a silent pause or fax tone may be recorded on the answering machine.

To use with an answering machine and computer, we recommend the following setup.

Always connect the fax machine directly to the wall jack.

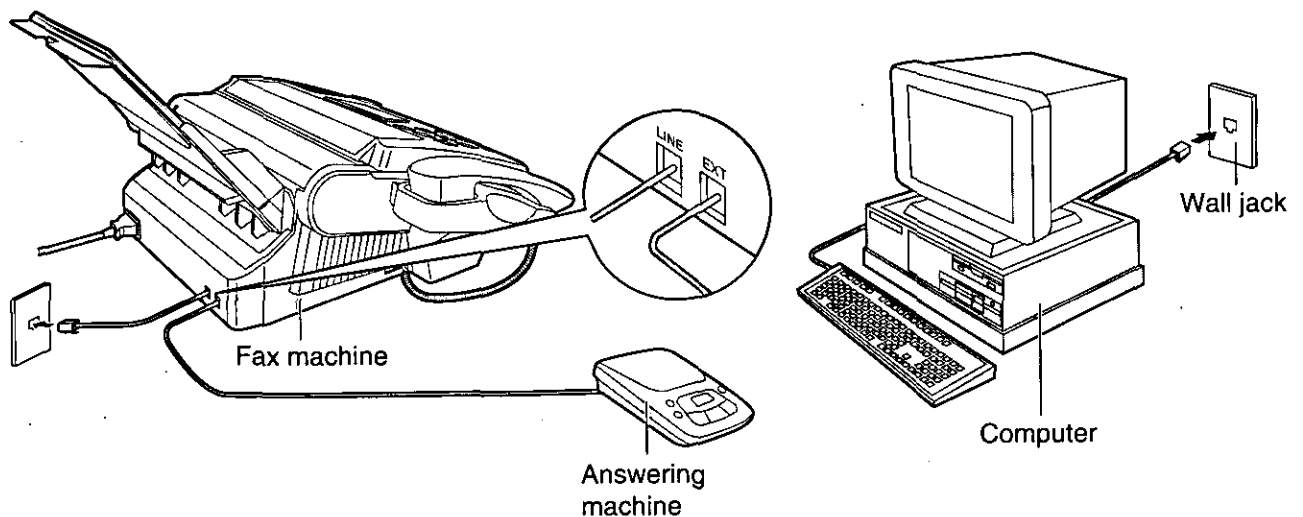

Note:

- Set the TEL mode on the fax machine.
- The equipment which has the shortest ring count will answer a call first. Confirm each equipment's ring count.
- If you use your computer as an answering machine, connect the telephone line cord from the EXT jack on the back of the fax machine to the computer.

Remote operation of your answering machine (remote activation ID)

Some answering machines will allow you to retrieve voice messages from a remote location. To deactivate the fax machine while you are checking your messages, set the remote activation ID code for the answering machine.

Important:

- This ID must be different from the fax activation code (see page 70).

- 1 Press **MENU**.
Display: 1. SYSTEM SET UP
- 2 Press **#**, then **1 2**.
REMOTE TAM ACT.
- 3 Press **START/COPY/SET**.
MODE=OFF ▼▲
- 4 Press ▼ or ▲ to select "ON".
MODE=ON ▼▲
- 5 Press **START/COPY/SET**.
ID=11

- The display will show the pre-selected ID.

- 6 Enter your ID number.
 - This ID can be from 1 to 5 digits in length using 0 - 9, * and #.

- 7 Press **START/COPY/SET**.
SETUP ITEM []

- 8 Press **MENU**.

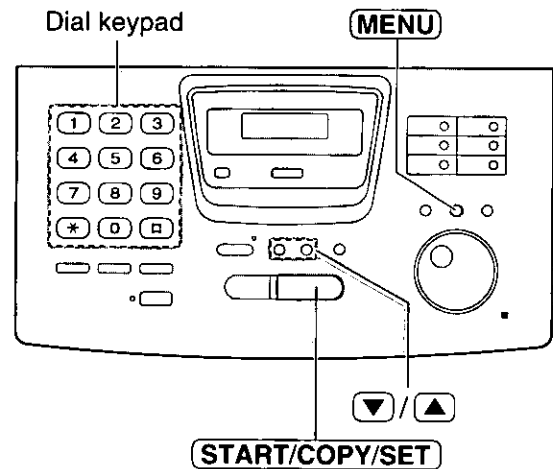

Receiving a voice message and fax document in one call

The caller can leave a voice message and send a fax document during the same call. Inform the caller of the following procedures beforehand.

1. The caller calls your fax machine.
 - The answering machine will answer the call.
2. The caller can leave their message after the greeting message.
3. The caller presses *** 9** (pre-selected fax activation code).
 - The fax machine will activate the fax function.
4. The caller presses their start button to send a document.

Note:

- The fax activation code can be changed (see page 70).
- If the wrong fax activation code is entered, the caller must wait at least 5 seconds to reenter the correct code.

Receiving Faxes

Distinctive Ring service ===== (ring pattern detection feature)





This feature can only be used when you subscribe to a Distinctive Ring service from your telephone company. For more information on the availability of this service, contact your telephone company before activating this feature.

This feature will work irregardless of the AUTO ANSWER or receive mode settings.

What is a Distinctive Ring service?

A Distinctive Ring service will give you up to 3 telephone numbers on a single telephone line, each having a different ringing pattern.

Ring patterns:

Standard ring (one long ring)	
Double ring (two short rings)	
Triple ring (short-long-short rings)	
Other triple ring (short-short-long rings)	

When you subscribe to a Distinctive Ring service, you can assign telephone numbers for personal telephone numbers, business telephone numbers, fax telephone numbers, and so on. When a call is received, you will know which number is being called by the ringing pattern.

Example:

Your telephone number	Ring pattern	Use
012 1234	Standard ring	Personal
012 5678	Double ring	Business
012 9876	Triple ring	Facsimile

To use one of the telephone numbers as a facsimile number

Program the ring pattern assigned to the facsimile number (see the next page). When the unit detects a call matching the selected Distinctive Ring pattern, it will activate the fax function.

Setting the Distinctive Ring pattern assigned for faxes

Select the ring pattern of the facsimile number that is assigned by your telephone company.

- 1 Press **MENU**.
Display: 1: SYSTEM SET UP
- 2 Press **□**, then **3 1**.
RING DETECTION
- 3 Press **START/COPY/SET**.
MODE=OFF ▼▲
- 4 Press ▼ or ▲ to select the ring pattern assigned to the facsimile number.
 - A: Standard ring (one long ring)
 - B: Double ring (two short rings)
 - C: Triple ring (short-long-short rings)
 - D: Other triple ring (short-short-long rings)
 - OFF: Turns off the feature (pre-selected setting).
- 5 Press **START/COPY/SET**.
PRINTING
 - The unit will print an information list.SETUP ITEM []
- 6 Press **MENU**.

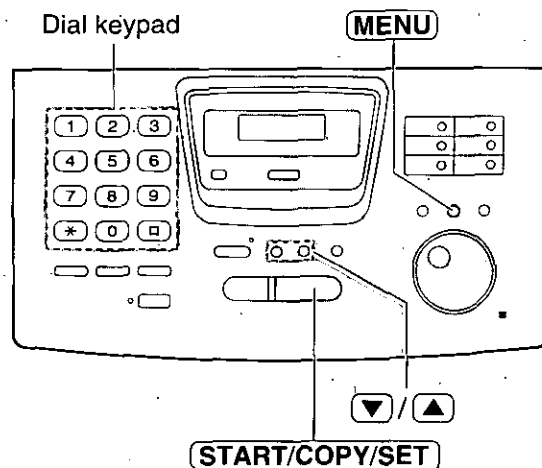

Note:

- The unit will automatically answer a Distinctive Ring call after the first ring regardless of the AUTO ANSWER, receive mode or ring count setting.
- If you have only 1 Distinctive Ring number, you most likely will use setting "B".

Receiving Faxes

TEL/FAX mode

(receiving voice calls with rings and fax calls without rings when you are near the unit)

Use this mode when you are always near the unit, are not using an answering machine, and you want the fax machine to detect faxes without ringing. When a call is received, the unit will work as follows. If you have connected an extension telephone, see page 67.

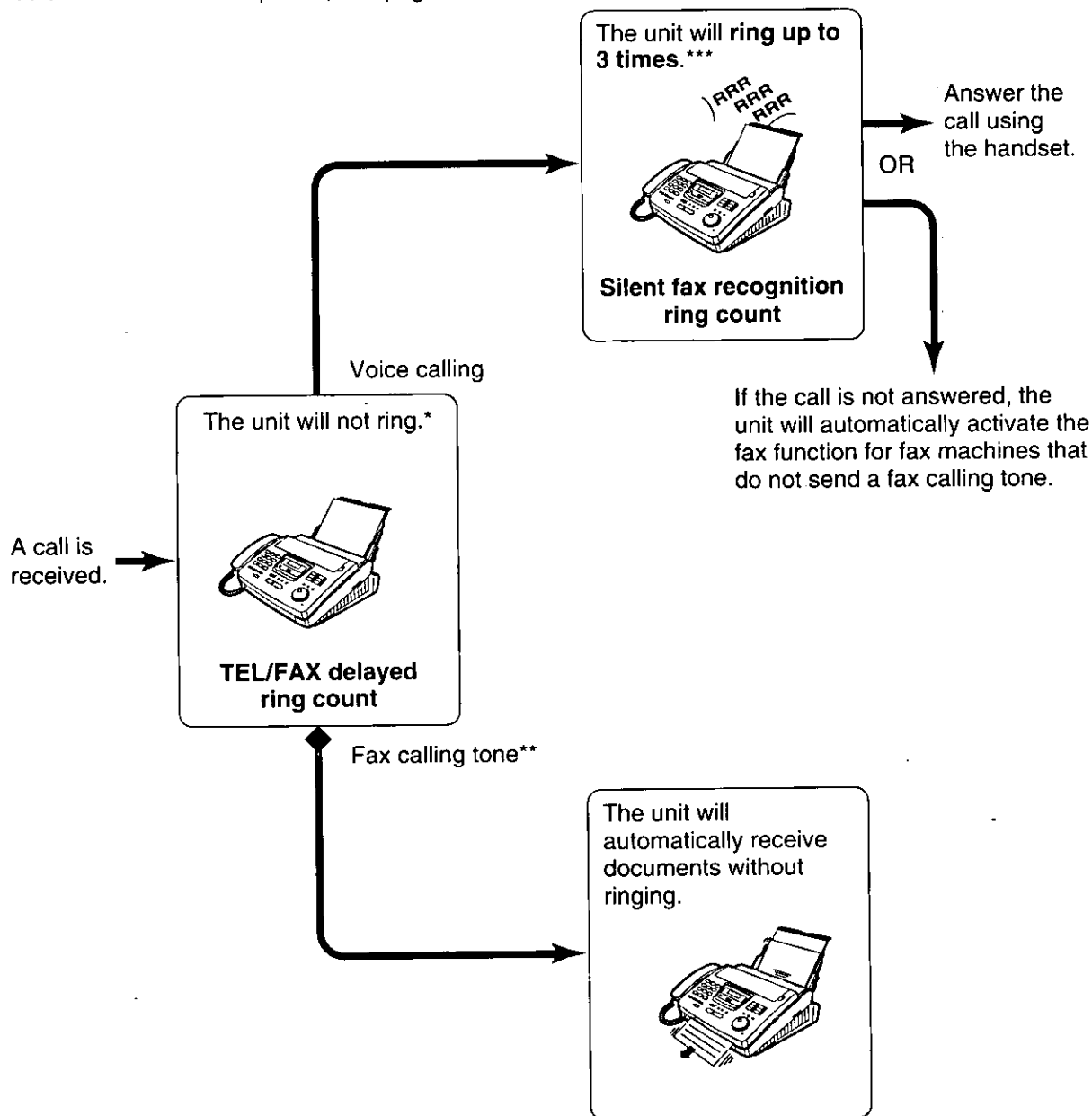

* A telephone fee will be charged to the caller from this point.

** A fax calling tone is automatically generated by the sending fax machine. Some fax machines do not have this capability.

*** While ringing, the unit will emit a different ring back tone to the calling party.

Note:

- Some fax messages that are transmitted manually may not send a fax calling tone. These calls must be received manually.
- You must set the ringer to ON.

Ring pattern when an extension telephone is connected

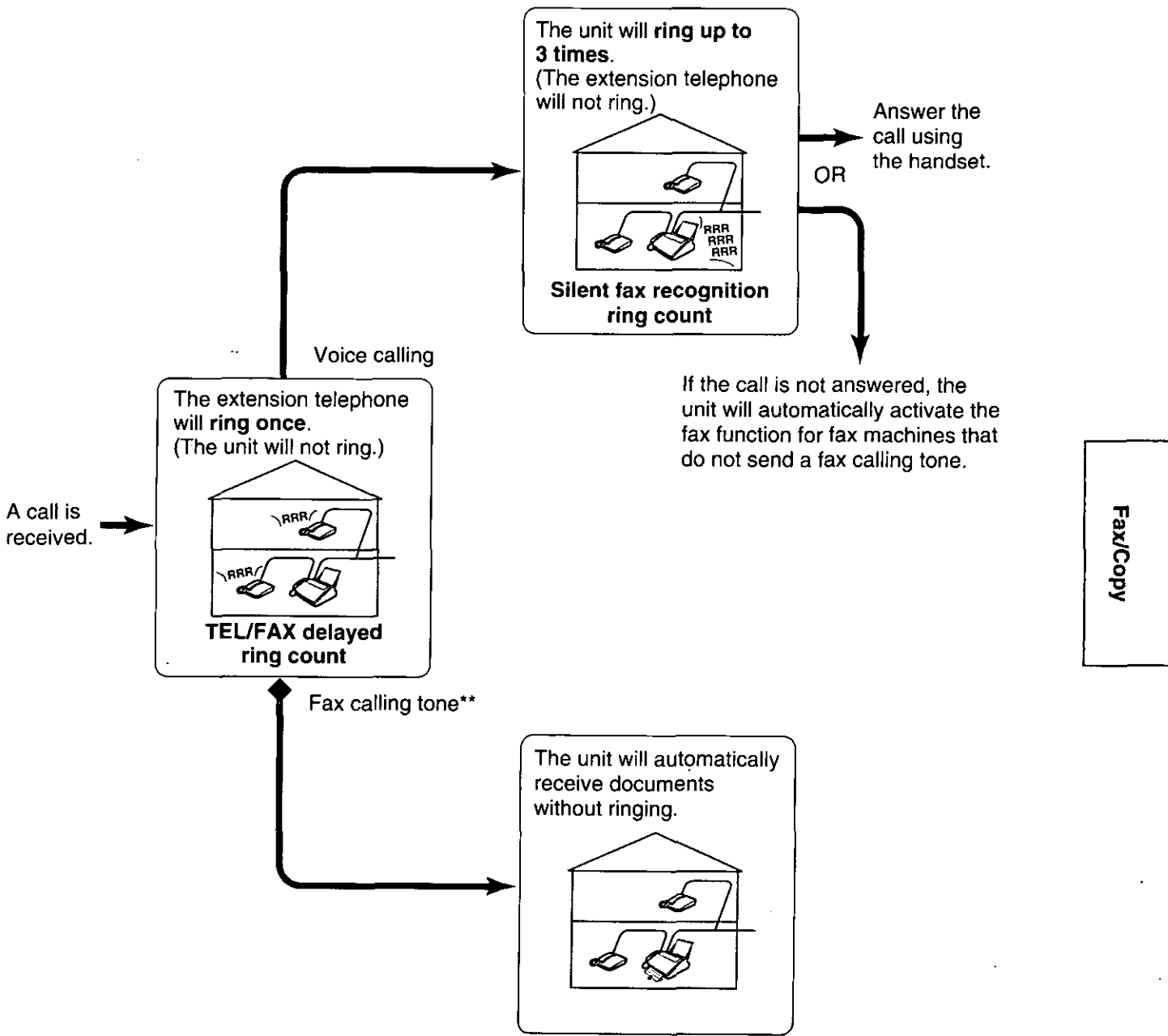

TEL/FAX delayed ring count:

One to four ring signals will be generated before the unit answers, depending on feature setting #78 on page 69. In the TEL/FAX mode, the unit will not generate an audible ring during this period.

Silent fax recognition ring count:

The unit generates audible rings to indicate that it is receiving a voice call. Three to six rings will be generated, depending on feature setting #30 on page 69. This signal will not ring at an extension telephone.

Note:

- The unit will display the following when an extension telephone starts to ring.

Display: INCOMING CALL

- You must set the ringer to ON.

Receiving Faxes

Changing the FAX ONLY mode to the TEL/FAX mode

Change the AUTO ANSWER setting from the FAX ONLY mode to the TEL/FAX mode.

- 1 Press **MENU**.
Display: 1.SYSTEM SET UP
- 2 Press **□**, then **7 7**.
AUTO ANSWER
- 3 Press **START/COPY/SET**.
MODE=FAX ONLY ▼▲
- 4 Press ▼ or ▲ to select "TEL/FAX".
MODE=TEL/FAX ▼▲
- 5 Press **START/COPY/SET**.
PRINTING
- The unit will print an information list.
SETUP ITEM []
- 6 Press **MENU**.
- 7 If the AUTO ANSWER light is off, turn it on by pressing **AUTO ANSWER**.
TEL/FAX MODE

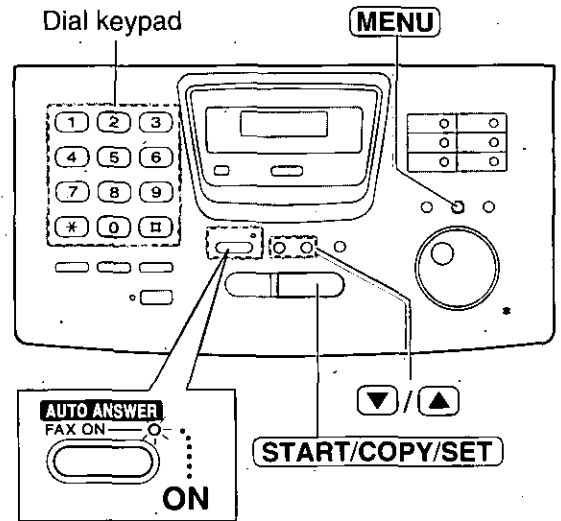

Note:

- To return to the FAX ONLY mode, select "FAX ONLY" in step 4.

We recommend the following setup.

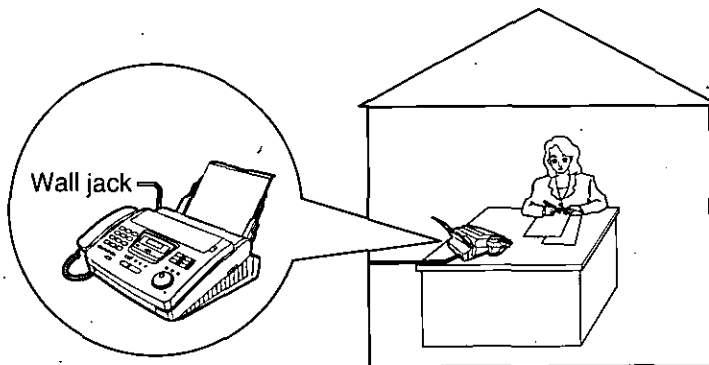

Only a fax machine is connected.

You are always close to the unit.

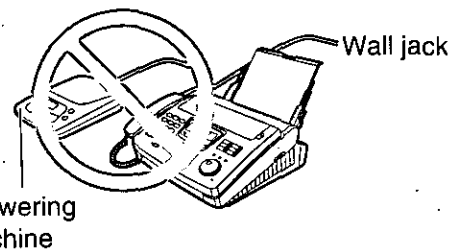

Answering machine

Do not connect an answering machine when using the TEL/FAX mode.

TEL/FAX delayed ring count

This setting determines the number of times the extension telephone rings in the TEL/FAX mode. You can choose from 1 to 4 rings.

When an extension telephone is not connected, this setting does not need to be changed.

- 1 Press **MENU**.
Display: 1.SYSTEM SET UP
- 2 Press **□**, then **7** **8**.
TEL/FAX RING
- 3 Press **START/COPY/SET**.
RING=1 ▼▲
- 4 Press ▼ or ▲ to select the desired number or enter the desired number using the dial keypad.
- 5 Press **START/COPY/SET**.
SETUP ITEM []
- 6 Press **MENU**.

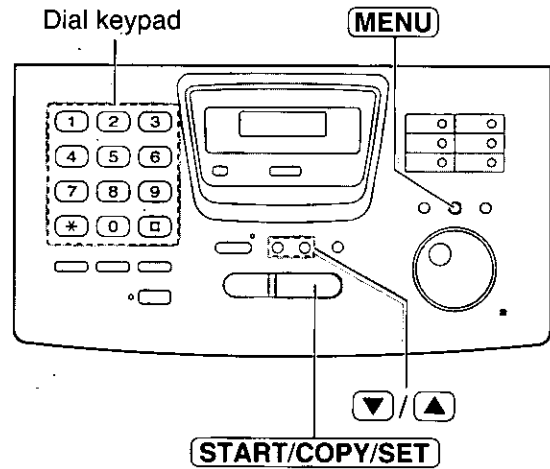

Note:

- If the number of rings is increased, you may not be able to receive documents from some older model fax machines which do not send a fax calling tone.

Fax/Copy

Silent fax recognition ring count

When the unit detects a voice call in the TEL/FAX mode, it will ring up to 3 times. The number of rings can be changed up to 6. If a voice call is not answered within the selected number of rings (3 to 6 rings), the unit will automatically start to receive a fax.

- 1 Press **MENU**.
Display: 1.SYSTEM SET UP
- 2 Press **□**, then **3** **0**.
SILENT FAX RING
- 3 Press **START/COPY/SET**.
RING=3 ▼▲
- 4 Press ▼ or ▲ to select the desired number or enter the desired number using the dial keypad.
- 5 Press **START/COPY/SET**.
SETUP ITEM []
- 6 Press **MENU**.

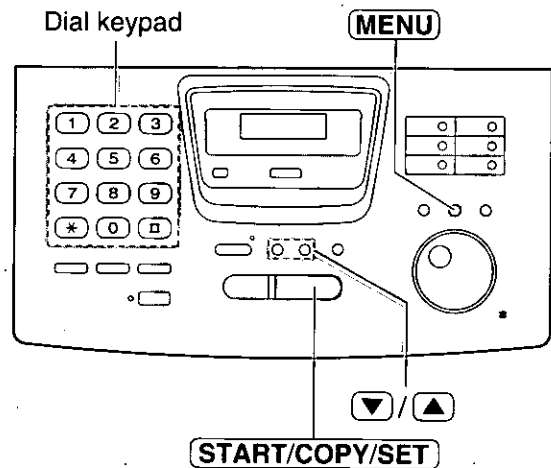

Note:

- If the number of rings is increased, you may not be able to receive documents from some older model fax machines which do not send a fax calling tone.

Receiving Faxes

Extension telephone

When you connect an extension telephone to your unit or on the same line, you can receive fax documents using the extension telephone.

You do not have to go to the unit and press **START/COPY/SET**.

Important:

- Use a touch tone telephone as the extension telephone and enter the fax activation code **firmly**.

- 1** When the extension telephone rings, lift the handset of the extension telephone.
- 2** When:
 - document reception is required,
 - a fax calling tone (slow beep) is heard, or
 - no sound is heard,press *** 9** (pre-selected fax activation code) **firmly**.
- 3** Hang up the handset.
 - The unit will start reception.

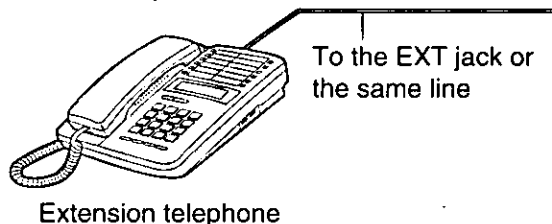

Note:

- You can change the fax activation code (see below).

Fax activation code

The fax activation code is used in the following cases;

- when receiving faxes using an extension telephone (see above).
- when receiving a voice message and fax document in the same call (see page 63).

Important:

- This code should be different from the remote activation ID (see page 63).

- 1** Press **MENU**.
Display: 1.SYSTEM SET UP
- 2** Press **□**, then **4 1**.
FAX ACTIVATION
- 3** Press **START/COPY/SET**.
MODE=ON ▼▲
- 4** Press ▼ or ▲ to select the desired setting.
 - If this feature is not required, select "OFF".
- 5** Press **START/COPY/SET**.
CODE= * 9
 - The display will show the pre-selected code.
- 6** Enter the new code number.
 - This code can be from 2 to 4 digits in length using 0 - 9 and *.
- 7** Press **START/COPY/SET**.
SETUP ITEM []
- 8** Press **MENU**.

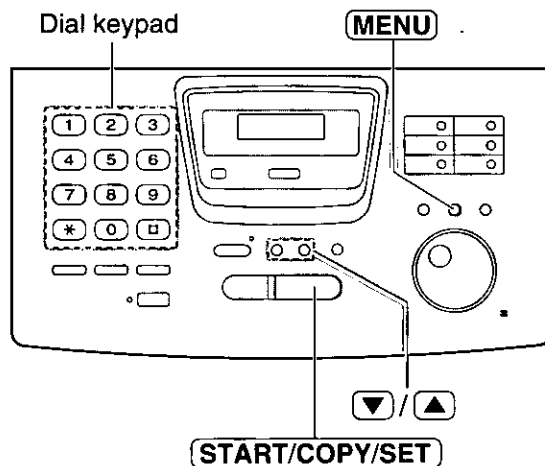

Note:

- If you subscribe to some special telephone company services, all or part of the fax activation code must be different from the service access code.
- The fax activation code should not be set to "0000".

Other size documents

When the size of the documents sent by the other party is as large as, or larger than the recording paper, the unit can reduce each page of the document and print it out on the recording paper by programming a suitable reduction rate.

The reduction rate is determined by a combination of the size of the recording paper and received document.

Recommended reduction rate:

Mode	Size of recording paper	Size of original document
100%	Legal	Letter, A4
92% (pre-selected)	Letter	Letter
	Legal	Legal
86%	Letter	A4
72%	Letter	Legal

Letter = 216 mm x 279 mm (8½" x 11")

Legal = 216 mm x 356 mm (8½" x 14")

A4 = 210 mm x 297 mm (May not be available in the United States.)

Fax/Copy

- 1 Press **MENU**.
Display: 1.SYSTEM SET UP
- 2 Press **⏏**, then **3** **6**.
RCV REDUCTION
- 3 Press **START/COPY/SET**.
MODE=92% ▼▲
- 4 Press ▼ or ▲ to select the desired setting.
• If this feature is not required, select "100%".
- 5 Press **START/COPY/SET**.
SETUP ITEM []
- 6 Press **MENU**.

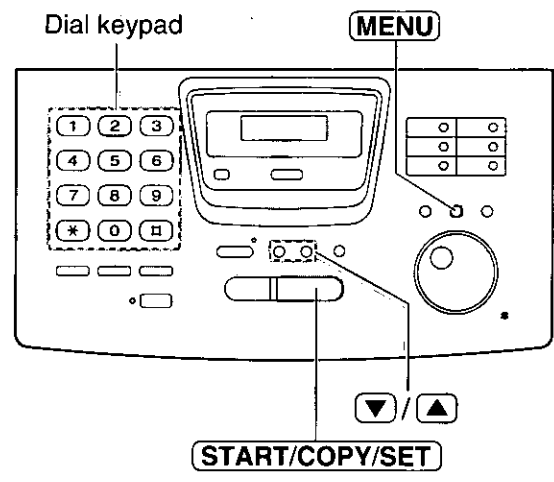

Note:

- Documents received by fax machines usually have a heading on the top of each page which contains the sender's name/telephone number. This increases the length of each page. Therefore, it is recommended to use the reduction mode.
- If the appropriate reduction rate is not programmed, the document will be divided.

Receiving Faxes

Silent detection (receiving faxes from older model fax machines)

This feature allows the unit to activate the fax function automatically if a silent pause longer than 4 seconds is detected when using an answering machine.

Helpful hints:

- If you wish to receive documents from fax machines that do not send a fax calling tone, activate this feature.
- If you use an answering machine to give greeting messages and record incoming messages on a single cassette tape, deactivate this feature.

- 1 Press **MENU**.
Display: 1.SYSTEM SET UP
- 2 Press **[]**, then **4 0**.
SILENT DETECT.
- 3 Press **START/COPY/SET**.
MODE=ON ▼▲
- 4 Press ▼ or ▲ to select the desired setting.
• If this feature is not required, select "OFF".
- 5 Press **START/COPY/SET**.
SETUP ITEM []
- 6 Press **MENU**.

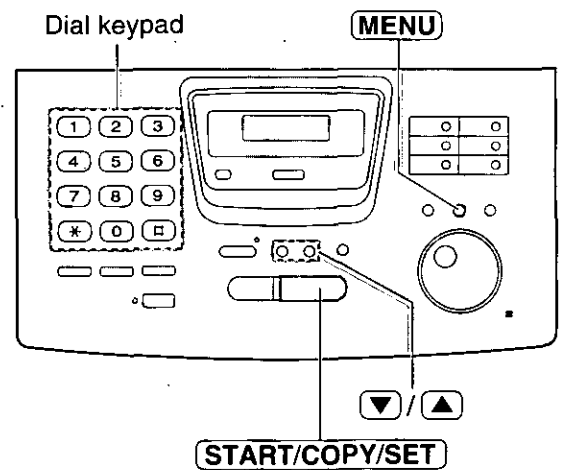

Memory reception alert

When received documents are stored into memory, the unit will alert you with beep tones. If you hear slow beeps, clear the printing problem or supply paper to print the stored documents. The beep tones will stop.

- 1 Press **MENU**.
Display: 1. SYSTEM SET UP
- 2 Press **Ⓜ**, then **4 4**.
RECEIVE ALERT
- 3 Press **START/COPY/SET**.
MODE=ON ▼▲
- 4 Press ▼ or ▲ to select the desired setting.
• If this feature is not required, select "OFF".
- 5 Press **START/COPY/SET**.
SETUP ITEM []
- 6 Press **MENU**.

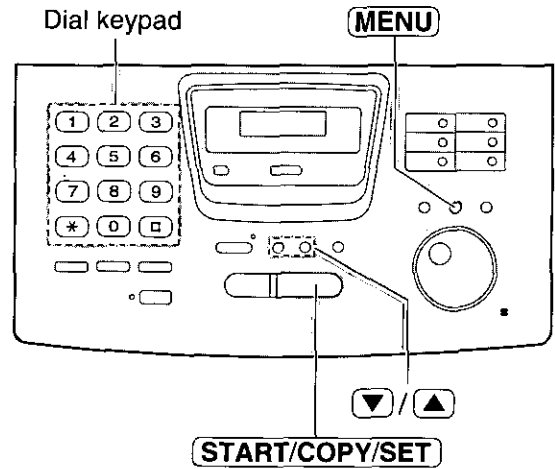

Fax/Copy

Friendly reception

The friendly reception feature allows you to receive fax documents automatically without pressing **START/COPY/SET** (see page 58).

When this feature is deactivated, you will have to press **START/COPY/SET** to receive fax documents each time you answer a fax call.

- 1 Press **MENU**.
Display: 1. SYSTEM SET UP
- 2 Press **Ⓜ**, then **4 6**.
FRIENDLY RCV
- 3 Press **START/COPY/SET**.
MODE=ON ▼▲
- 4 Press ▼ or ▲ to select the desired setting.
• If this feature is not required, select "OFF".
- 5 Press **START/COPY/SET**.
SETUP ITEM []
- 6 Press **MENU**.

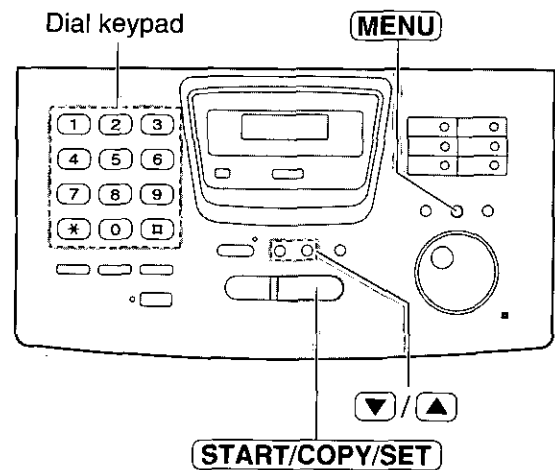

Receiving Faxes

Pager call - when your unit receives a fax

This feature allows your unit to call your pager when your unit receives a fax document.

1 Press **MENU**.
 Display: 1. SYSTEM SET UP

2 Press **[]**, then **7 0**.
 FAX PAGER CALL

3 Press **START/COPY/SET**.
 MODE=OFF

4 Press **[v]** or **[^]** to select "ON".
 MODE=ON

• If this feature is not required, select "OFF".

5 Press **START/COPY/SET**.
 NO. =

6 Enter your pager number.
 • You can enter a total of 46 digits and/or pauses.
 Example:

1 202 555 1234PPP12345678PPP5555#

Your pager number

Pauses

Your pager access code, if required.

Message you want to see on your pager when you receive a fax.

7 Press **START/COPY/SET**.
 • The unit will dial the stored number.
 PAGER TEST

8 Confirm if the message is displayed on your pager.

9 Press **SP-PHONE**.

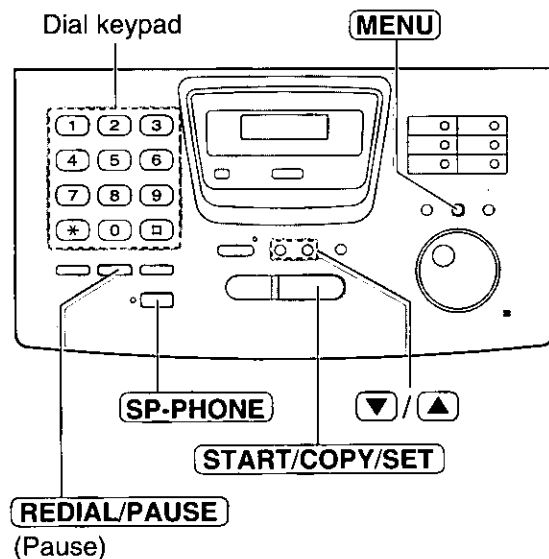

How your unit and pager work

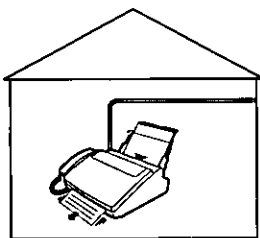

When your unit receives a fax document, it will call your pager company.

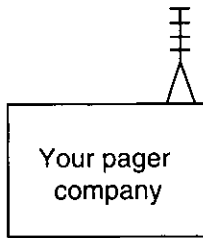

Your pager company will call your pager.

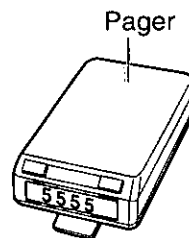

A few minutes later, your pager will display the same message you entered in step 6. (For this example: 5555)

Film detection

If this feature is activated, the display will show the following message when the remaining film prints about 15 letter size documents.

Display: FILM NEAR EMPTY

- If you are using regular film (100 m roll) when the above message is displayed, the unit will also print a report.

1 Press **MENU**.
Display: 1.SYSTEM SET UP

2 Press **⏏**, then **7** **9**.
FILM DETECTION

3 Press **START/COPY/SET**.
MODE=ON ▼▲

4 Press ▼ or ▲ to select the desired setting.
• If this feature is not required, select "OFF".

5 Press **START/COPY/SET**.
SETUP ITEM []

6 Press **MENU**.

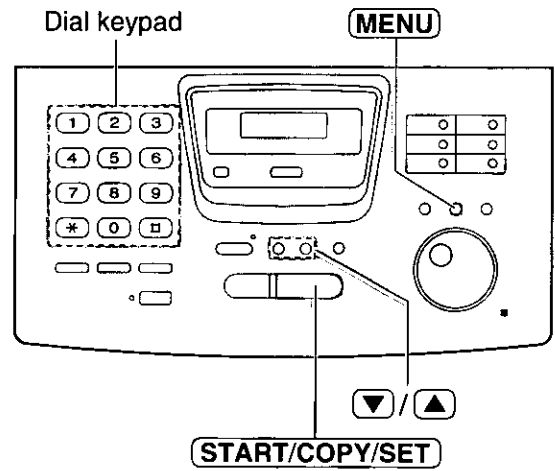

Copying

Making a copy

The unit can make single or multiple copies (up to 99). Any transmittable document (see page 47) can be copied.

- 1 Open the document feeder tray.
 - If the display shows "CHECK PAPER", make sure you **pull the paper set lever** when installing paper.

- 2 Adjust the width of the document guides to the size of the document.

- 3 Insert the document (up to 15 pages) **FACE DOWN** until a single beep is heard and the unit grabs the document.

Display: STANDARD

- Make sure the handset is hung up.

- 4 If necessary, press **RESOLUTION** repeatedly to select the desired setting (see the bottom of page 41).

- 5 Press **START/COPY/SET**.

NUMBER=1 [100%]

- 6 Enter the number of copies (up to 99).

- 7 If necessary, choose an enlargement/reduction rate by pressing **ZOOM** (∇ / \blacktriangle). See the next page.

- If you select "200%", you cannot make multiple copies (see the instructions on the right) or change the resolution.

- 8 If you wish to print collated, press **COLLATE** until the following is displayed. See the instructions on the next page.

COLLATE=ON

- 9 Press **START/COPY/SET**.

- The unit will start printing.

COPYING

Note:

- If a resolution is not selected, FINE resolution will automatically be selected.
- You can make or receive a voice call while making copies.
- After copying, the enlargement/reduction rate setting will return to "100%".

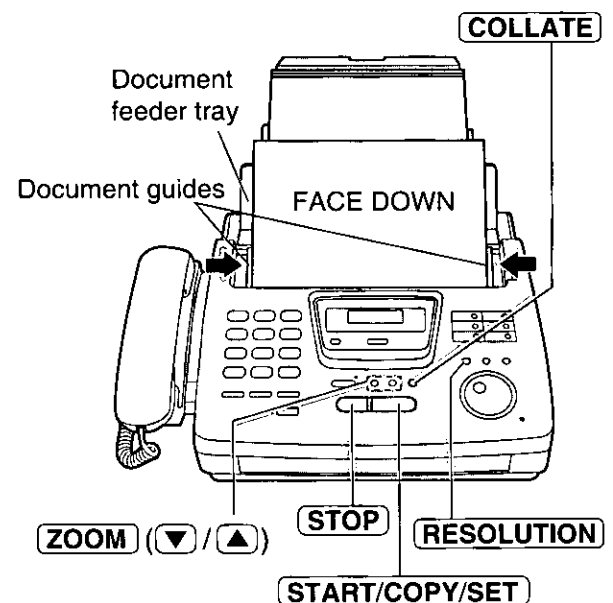
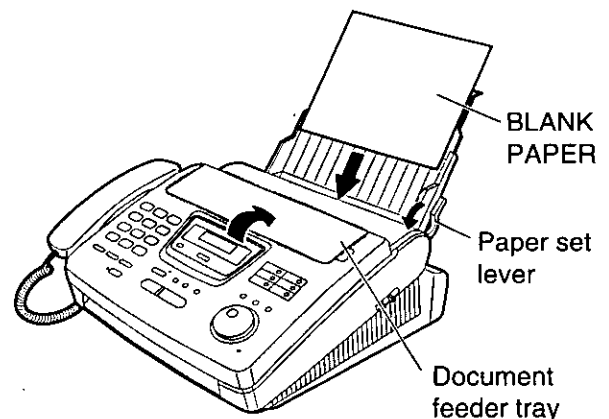

To stop copying

Press **STOP**.

To eject the document, press **STOP** again.

To make multiple copies of an enlarged document

Make a single enlarged copy by selecting "200%" using **ZOOM** (\blacktriangle) first, then make multiple copies of the enlarged document.

Printing collated

The unit will print uncollated. You can also print collated. See the example below.

For example: Making two copies of 4 page original document

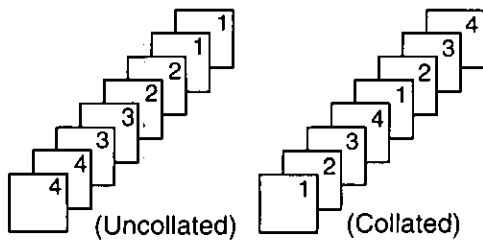

- If you turn the collating feature on, the unit will store the document into memory and print it. If memory becomes full while storing, the unit will only print out the stored pages.
- After copying, the collating feature will turn off automatically.

Choosing an enlargement/reduction rate

The unit can make enlarged or reduced copies of a document.

■ To enlarge a document:

Select "200%" by pressing **ZOOM** (\blacktriangle), then insert the document into the unit from the top side. The unit will only enlarge the center part of the top half of the document. See the example below.

Sample of an enlarged copy:

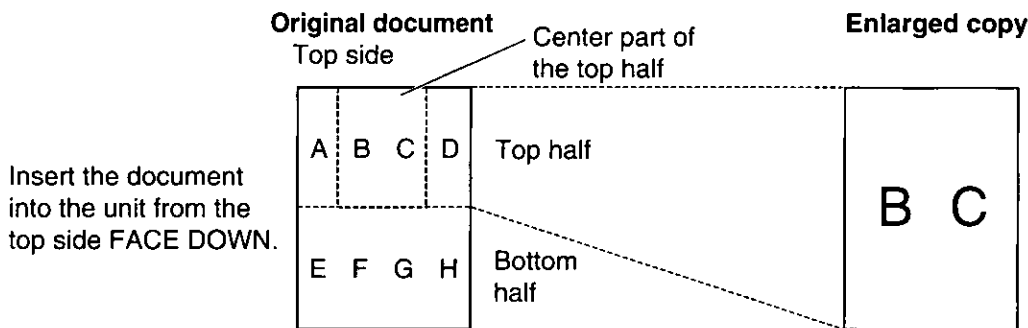

Fax/Copy

■ To reduce a document:

When you copy documents that are longer than the recording paper, the unit can reduce the original document by programming a suitable reduction rate. The reduction rate is determined by the size of the recording paper and original document. Select among 100%, 92%, 86% and 72% by pressing **ZOOM** (\blacktriangledown / \blacktriangle).

Recommended reduction rate:

Mode	Size of recording paper	Size of original document
100% (pre-selected)	Letter	Letter
	Legal	Letter, A4, Legal
92%	Letter	A4
86%	Letter	A4
72%	Letter	Legal

Letter = 216 mm x 279 mm (8½" x 11")

Legal = 216 mm x 356 mm (8½" x 14")

A4 = 210 mm x 297 mm (May not be available in the United States.)

Note:

- If the appropriate reduction rate is not programmed, the document may be divided and the top of the second sheet will be deleted.

Error Messages

Printed reports

When your fax does not transmit, check the following items first.

- The number you dialed is correct, and
- The other party's machine is a facsimile.

If the problem remains, correct the problem by following the communication message printed on the sending and journal reports (see pages 48 and 49).

Communication message	Error code	Cause & Remedy
COMMUNICATION ERROR	41-72 FF	● A transmission or reception error occurred. Try again or check with the other party.
DOCUMENT JAMMED	—	● The document is jammed. Remove the jammed document (p. 87).
ERROR-NOT YOUR UNIT	54, 59 70	● A transmission or reception error occurred because of a problem with the other party's fax machine. Check with the other party.
MEMORY FULL	—	● The document was not received due to memory being full.
NO DOCUMENT	—	● The document was not fed into the unit properly. Reinsert the document and try again.
OTHER FAX NOT RESPOND	—	<ul style="list-style-type: none">● The other party's fax machine was busy or ran out of recording paper. Try again.● The document was not fed properly. Reinsert the document and try again.● The other party's fax machine rings too many times. To send a fax manually, dial the number, confirm the fax tone, and press START/COPY/SET.● The other party's machine is not a facsimile. Check with the other party.● The number you dialed is not in service.
PRESSED THE STOP KEY	—	● The STOP button was pressed and fax communication was canceled.
THE COVER WAS OPENED	—	● The cover was opened. Close it and try again.
OK	—	● Fax communication was successful.

LCD display

If the unit detects a problem, one or more of the following messages will appear on the display.

Display message	Cause & Remedy
CALL SERVICE	<ul style="list-style-type: none"> There is something wrong with the unit. Contact our service personnel.
CHECK COVER	<ul style="list-style-type: none"> The cover is open. Close it.
CHECK DOCUMENT	<ul style="list-style-type: none"> The document is not fed into the unit properly. Reinsert the document. If misfeeding occurs frequently, clean the document feeder rollers and try again (p. 90). If the problem remains, adjust the feeder pressure (p. 87).
CHECK FILM	<ul style="list-style-type: none"> The film cartridge is not inserted properly. Reinsert it correctly (p. 88, 89).
CHECK LEVER	<ul style="list-style-type: none"> The recording paper set lever is released. Push it back to set the lever (p. 23).
CHECK MEMORY	<ul style="list-style-type: none"> Memory (telephone numbers, parameters, etc.) has been erased. Re-program.
CHECK PAPER	<ul style="list-style-type: none"> The recording paper is not installed or the unit ran out of paper. Install paper (p. 22). The recording paper is not fed into the unit properly or has jammed near the recording paper entrance. Clear the jammed paper (see "When paper has jammed near the recording paper entrance" on page 86). Do not install folded or heavily curled paper in the paper tray.
FAX IN MEMORY	<ul style="list-style-type: none"> The unit has (a) document(s) in memory. See the other message instructions to print out the document(s).
FILM EMPTY	<ul style="list-style-type: none"> The film is empty. Replace the film or film cartridge with a new one (p. 88, 89). The film is slack. Tighten it (see step 9 on page 89) and install again.
FILM NEAR EMPTY	<ul style="list-style-type: none"> The remaining film can print about 15 pages of letter size documents. Prepare a new film or film cartridge (p. 14).
FREE FILM EMPTY	<ul style="list-style-type: none"> The free starter film is empty. Replace the film or film cartridge with a new one (p. 88, 89).
JOG-DIAL FULL	<ul style="list-style-type: none"> There is no space to store new stations in the JOG DIAL directory. Edit or erase unnecessary stations (p. 38).
LOADING ERROR	<ul style="list-style-type: none"> A loading error occurred while receiving data from FaxSav. Contact FaxSav at 1-888-332-9728.
MEMORY FULL	<ul style="list-style-type: none"> Memory is full of received documents due to a lack of recording paper or a recording paper jam, etc. Install paper or clear the jammed paper. When performing memory transmission, the document being stored exceeds the memory capacity of the unit. Transmit the entire document by using manual or automatic transmission.
NO FAX REPLY	<ul style="list-style-type: none"> The other party's fax machine is busy or ran out of recording paper. Try again.



(continued)

Error Messages

Display message	Cause & Remedy
PAPER JAMMED	<ul style="list-style-type: none">● A recording paper jam occurred under the film cartridge. Clear the jammed paper (p. 85).
PLEASE WAIT	<ul style="list-style-type: none">● The unit is checking if the film is set correctly. Wait for a while.
REDIAL TIME OUT	<ul style="list-style-type: none">● The other party's fax machine is busy or ran out of recording paper. Try again.
REMOVE DOCUMENT	<ul style="list-style-type: none">● The document is jammed. Remove the jammed document (p. 87).● Attempted to transmit a document longer than 600 mm (23⁵/₈"). Press the STOP button to remove the document. Divide the document into two or more sheets and try again.
TRANSMIT ERROR	<ul style="list-style-type: none">● A transmission error occurred. Try again.
UNIT OVERHEATED	<ul style="list-style-type: none">● The unit is too hot. Let the unit cool down.

When a function does not work, check here before requesting help

General

Problem	Cause & Remedy
I cannot make and receive calls.	<ul style="list-style-type: none"> The power cord or telephone line cord is not connected. Check the connections (p. 24).
I cannot make calls.	<ul style="list-style-type: none"> The dialing mode setting is wrong. Change to "TONE" or "PULSE" (p. 33).
The unit does not work.	<ul style="list-style-type: none"> Disconnect the unit from the telephone line and connect the line to a known working telephone. If the working telephone operates properly, contact our service personnel to have the unit repaired. If the working telephone does not operate properly, contact your telephone company.
The unit does not ring.	<ul style="list-style-type: none"> The ringer volume is set to off. Adjust it to a suitable level (p. 29).
The other party complains they only hear a fax tone and cannot talk.	<ul style="list-style-type: none"> The FAX ONLY mode is set. Tell them the number is used for faxes only or change to another mode (p. 56, 57).
The speakerphone is not working as expected.	<ul style="list-style-type: none"> Use the speakerphone in a quiet room. If you have difficulty hearing the other party, adjust the volume using  or . If parts of your conversation are cut off, you and the other party spoke at the same time. Speak alternately.
The REDIAL/PAUSE button does not function properly.	<ul style="list-style-type: none"> If this button is pressed during dialing, a pause will be inserted. If pressed immediately after a dial tone is obtained, the last number dialed will be redialed.
The receive mode does not function as explained on page 56.	<ul style="list-style-type: none"> A Distinctive Ringing pattern is set (p. 64, 65). The TEL/FAX mode is set (p. 66 to 69).
During programming, I cannot enter the code or the ID number.	<ul style="list-style-type: none"> All or part of their numbers are the same. Change the number (p. 63, 70).
Film does not last long enough.	<ul style="list-style-type: none"> The HELP button, copy function, and reports all use film.

Help

Fax transmission

Problem	Cause & Remedy
I cannot send documents.	<ul style="list-style-type: none"> The telephone line cord is connected to the EXT jack on the unit. Connect to the LINE jack (p. 24). The other party's fax machine was busy or ran out of paper. Try again. The other party's machine is not a facsimile. Check with the other party. The other party's fax machine rings too many times. Send a fax manually - dial the number, confirm the fax tone, then press START/COPY/SET.

(continued)

Operations

Fax transmission

Problem	Cause & Remedy
The other party complains that letters on their received document are distorted.	<ul style="list-style-type: none"> ● If your line has special telephone services such as call waiting, the service may have been activated during fax transmission. Connect the unit to a line that does not have these services. ● The extension telephone on the same line is off the hook. Hang up the extension telephone and try again.
The other party complains that dirty patterns or black lines appear on their received documents.	<ul style="list-style-type: none"> ● The glass or rollers are dirty. Clean them (p. 90).
I cannot make an international fax call.	<ul style="list-style-type: none"> ● Use the overseas transmission mode (p. 54). ● Add two pauses at the end of the telephone number (p. 32) or dial manually.



Fax reception

Problem	Cause & Remedy
I cannot receive documents.	<ul style="list-style-type: none"> ● The telephone line cord is connected to the EXT jack on the unit. Connect to the LINE jack (p. 24).
I cannot receive documents automatically.	<ul style="list-style-type: none"> ● The receive mode is set to the TEL mode. Set to the FAX ONLY or TEL/FAX mode. ● The time to answer the call is too long. Decrease the number of rings (p. 60, 69).
The display shows "CONNECTING....." but faxes are not received.	<ul style="list-style-type: none"> ● The incoming call is not a fax. Change the receive mode.
The recording image is faint.	<ul style="list-style-type: none"> ● The sender transmitted a faint document. Ask them to transmit a clearer copy of the document. ● The thermal head is dirty. Clean it (p. 90).
The printing quality is poor.	<ul style="list-style-type: none"> ● Some paper has instructions recommending which side to print on. Try turning the paper over. We recommend smooth paper such as Hammermill® Jet Print for clearer printing.
A blank sheet is ejected after the received documents are printed out.	<ul style="list-style-type: none"> ● The receiving reduction rate is not programmed correctly. Program the proper rate (p. 71).

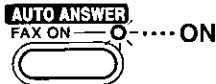
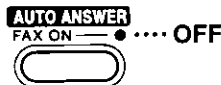
Receive mode

Problem	Cause & Remedy
I cannot select the desired receive mode.	<ul style="list-style-type: none"> ● If you set the FAX ONLY or TEL/FAX mode: <ul style="list-style-type: none"> – Select the desired mode using feature #77 (p. 68), and – Press AUTO ANSWER to turn on the AUTO ANSWER light.  ● If you set the TEL mode: <ul style="list-style-type: none"> – Press AUTO ANSWER to turn off the AUTO ANSWER light. 

Copying

Problem	Cause & Remedy
When you try to make a copy, the unit beeps and the display shows "CHECK PAPER".	<ul style="list-style-type: none"> ● Pull the paper set lever, make sure the paper is inserted correctly and push the paper set lever.
The unit does not make a copy.	<ul style="list-style-type: none"> ● You may be programming the unit. Try to make a copy after programming or stop the programming.
A dirty pattern or a black line appears on the copied documents.	<ul style="list-style-type: none"> ● The glass or rollers are dirty. Clean them (p. 90).
The copied image is distorted.	<ul style="list-style-type: none"> ● The thermal head is dirty. Clean it (p. 90).
The document is not copied properly.	<ul style="list-style-type: none"> ● The film is not inserted correctly. Insert it correctly (p. 88, 89).
The copied document is blank.	<ul style="list-style-type: none"> ● The film is not inserted correctly. Insert it correctly (p. 88, 89).
The printing quality is poor.	<ul style="list-style-type: none"> ● Some paper has instructions recommending which side to print on. Try turning the paper over. We recommend smooth paper such as Hammermill® Jet Print for clearer printing.
The printing is light. Original  Copy 	<ul style="list-style-type: none"> ● You may have used paper with a cotton and/or fiber content that is over 20%, such as letterhead or resume paper. We recommend smooth paper such as Hammermill® Jet Print for clearer printing.
A paper jam occurs during copying.	<ul style="list-style-type: none"> ● The film is not inserted correctly. Insert it correctly (p. 88, 89).

Help

Using an answering machine

Problem	Cause & Remedy
I cannot receive documents automatically.	<ul style="list-style-type: none"> ● Your greeting message on the answering machine is too long. Shorten the message (up to 10 seconds). ● The answering machine rings too many times. Set to 1 or 2 rings. ● The silent detection feature is deactivated. Activate this feature (p. 72).
I cannot receive voice messages.	<ul style="list-style-type: none"> ● Check if the answering machine is turned on and connected to the unit properly (p. 61). ● Set the number of rings on the answering machine to 1 or 2.
I cannot retrieve recorded voice messages on the answering machine from a remote location.	<ul style="list-style-type: none"> ● The remote access code on your answering machine is the same as your fax activation code. Set a different number for each code. ● You did not program your remote access code in your fax machine correctly. Program the same code that is programmed on the answering machine (p. 63).

(continued)

Operations

Using an answering machine

Problem	Cause & Remedy
The greeting message on your answering machine is interrupted halfway and the caller cannot leave a voice message.	<ul style="list-style-type: none"> The greeting message has a silent pause longer than 4 seconds. Re-record the greeting message.
I pressed the remote access code to access the answering machine remotely, but the line was disconnected.	<ul style="list-style-type: none"> The code may include “#” which is used for certain features provided by the telephone company. Change the code on the answering machine to another number which does not include “#” (p. 63).
Callers complain that their voice message is interrupted halfway and they cannot leave a message.	<ul style="list-style-type: none"> Advise the caller not to pause for over 4 seconds while recording their voice message.
Callers complain that they cannot send a document.	<ul style="list-style-type: none"> Your answering machine ran out of recording tape. Rewind the tape to record messages. You set the answering machine to only give a greeting message.
When I answer a call with the extension telephone, the unit switches to the fax mode and I cannot talk with the other party.	<ul style="list-style-type: none"> You paused for over 4 seconds during the conversation. To resume the conversation, press the STOP button on the unit.

If a power failure occurs

- The unit will not function.
- Transmission and reception will be interrupted. Check the transactions by printing a journal report.
- If fax documents are stored in memory, they will be lost. When power is restored, a power-down report will be printed out stating which contents in memory have been erased.
- If delayed transmission is programmed and the start time has passed during a power failure, transmission will be attempted soon after power is restored.
- If an extension telephone/answering machine is connected to the unit, you can use it during a power failure.

Power-down report

The power-down report will be automatically printed out after power is restored.
The report will not be printed out when there are no documents stored in memory.

Sample of a power-down report

POWER DOWN REPORT				
			POWER DOWN AT:Jan. 05 1998 04:30AM	
			RESTARTED AT:Jan. 05 1998 04:31AM	
<< WARNING >>				
CONTENTS HAVE BEEN CLEARED DUE TO POWER DOWN.				
FOR ADDITIONAL INFORMATION, PLEASE SEE THE JOURNAL REPORT.				
NO.	OTHER FACSIMILE	MODE	PAGES	FUNCTION
01	<FAX # NOT AVAIL.>	RCV	01	MEMORY RECEIVE

Recording paper jam

If the unit does not eject any recording paper during reception or copying, the recording paper has jammed. Remove the jammed paper by following the display message on this page and page 86.

When paper has jammed under the film cartridge

The display will show the following message.

Display: PAPER JAMMED

Remove the jammed paper as follows.

- 1** Slide the cover open lever forward.
- 2** The cover is under tension to improve print quality. Pull up hard enough to open.
- 3** Remove the film cartridge.
- 4** Remove the jammed recording paper.

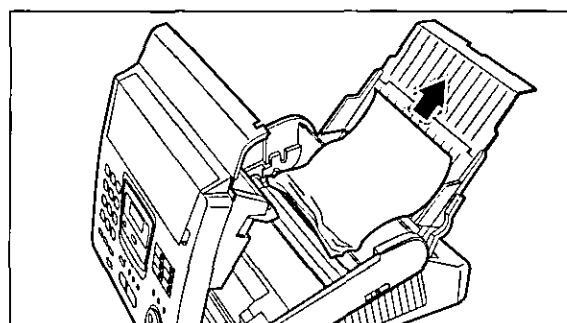
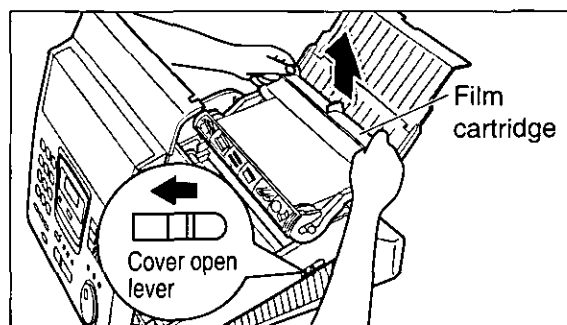

- 5** If the film is slack, tighten it by winding the bottom side gears.

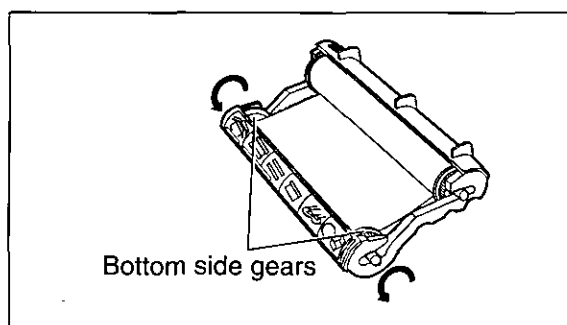
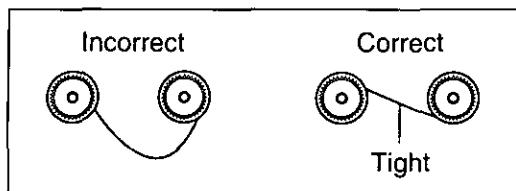

- 6** Replace the film cartridge by matching the blue label side of the cartridge with the one on the unit.

- 7** Close the cover securely by pushing down on both corners.

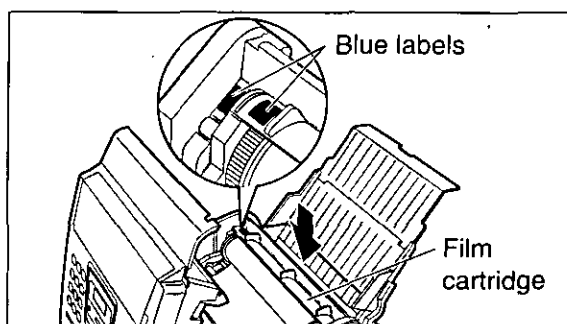

Help

Jams

When paper has jammed near the recording paper entrance

The display will show the following message.

Display: CHECK PAPER

Remove the jammed paper as follows.

Pull the recording paper set lever forward, then pull out the jammed recording paper from the recording paper entrance.

Push the set lever back.

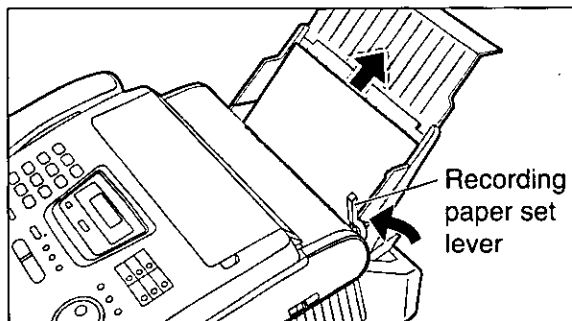

When paper has not been ejected though neither "PAPER JAMMED" nor "CHECK PAPER" is displayed

Confirm the recording paper exit. If there is a jammed paper, remove it as follows:

- 1 First, lift the front of the unit. Pull the stacker forward until it stops, then press the center slots to unlock and remove the stacker.

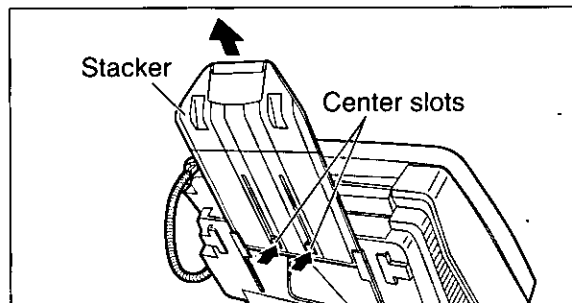

- 2 Tilt the unit up and push the jammed recording paper out through the triangular window on the bottom of the unit.

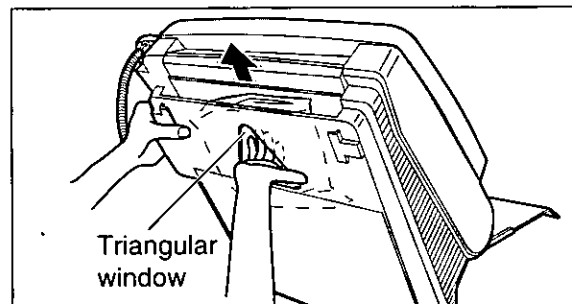

- 3 Remove the jammed recording paper from the recording paper exit.
 - If you cannot remove the jammed paper, remove it by following the instructions on page 85.

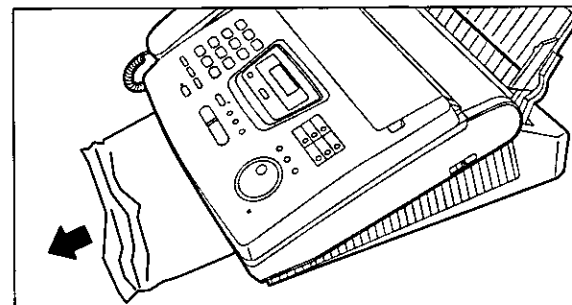

Sending document jams

If the unit does not release the document during feeding, remove the document as follows.

- 1** Slide the cover open lever forward.
- 2** The cover is under tension to improve print quality. Pull up hard enough to open.
- 3** Remove the jammed document carefully.
- 4** Close the cover securely by pushing down on both corners.

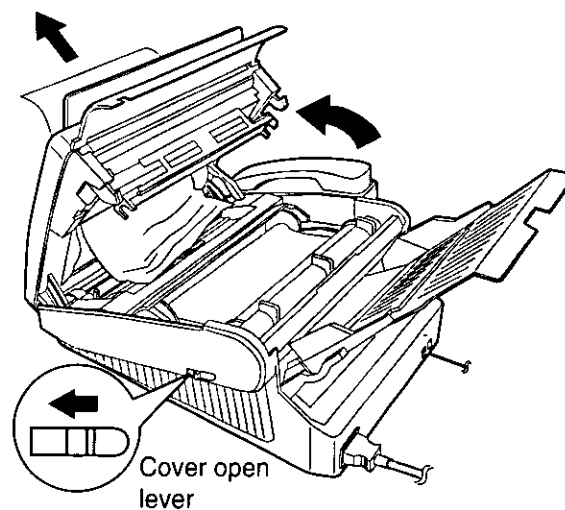

Sending documents does not feed, or multi-feeds

If no feeding or multiple feeding occurs frequently, adjust the feeder pressure.

- 1** Slide the cover open lever forward.
- 2** The cover is under tension to improve print quality. Pull up hard enough to open.
- 3** Shift the position of the lever by using an instrument with a pointed end, like a paper clip.
 - Position A:** When documents do not feed.
 - Position B:** Standard position (pre-selected)
 - Position C:** When documents multiple feed.
- 4** Close the cover securely by pushing down on both corners.

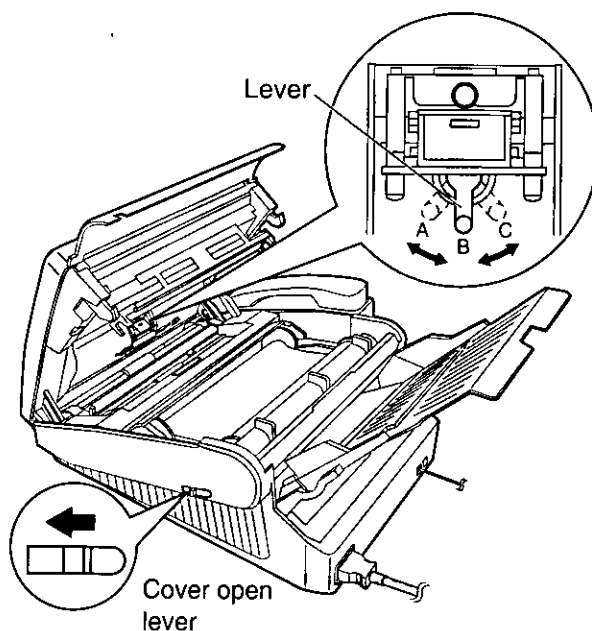

Help

How much film you have left

To check the amount of remaining film, press **FILM REMAINING** while the unit is idle. The display indicates the approximate amount of remaining film.

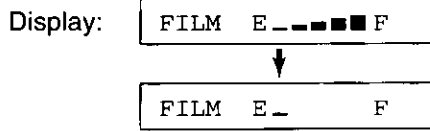

When the film indicator points to this position, the remaining film will print up to 25 pages of letter size documents. Prepare a new film or film cartridge for replacement.

Replacing the film or film cartridge

When the unit detects the end of the film, the following message will be displayed.

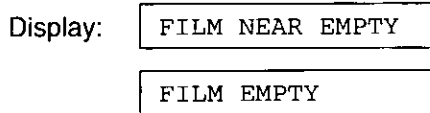

The remaining film prints about 15 pages of letter size documents. Prepare a new film or film cartridge.

The film is empty. Install a new film or film cartridge.

The following replacement kits are available:

KX-FA135: Film cartridge (1 cartridge and 1 film)

KX-FA136: Replacement film (2 films)

To order replacement kits, see page 14.

- 1** Slide the cover open lever forward.
- 2** The cover is under tension to improve print quality. Pull up hard enough to open.
- 3** Remove the film cartridge.
 - If you have purchased a film cartridge (Model no. KX-FA135) for replacement, skip to step 10.
 - To replace only the film, go to step 4.
- 4** Unlock the four gears by (A) pulling the top side gears (blue and green gears) forward and (B) pushing back the bottom side gears (green gears). Remove the used film.

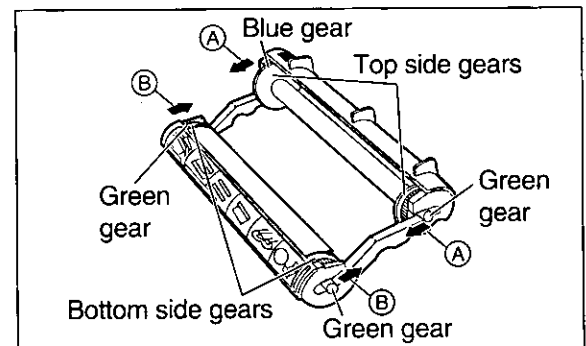
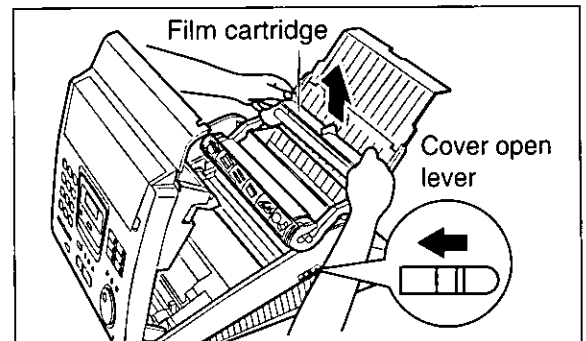

- 5** Remove the four gears from the used film cores.

Caution:

- The film is not reusable. You can order a new film for replacement through your nearest Panasonic dealer or call 1-800-435-7329.

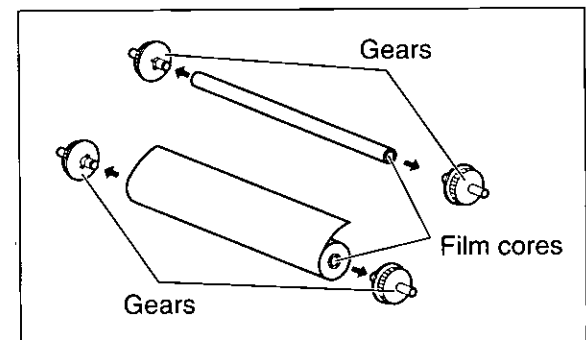

6 Insert the blue gear into the blue core of the new film.

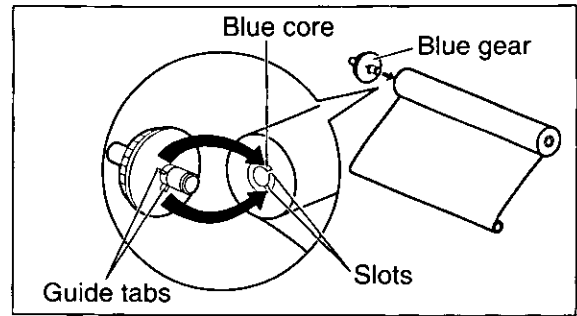

7 Insert the three green gears into the remaining cores of the new film.

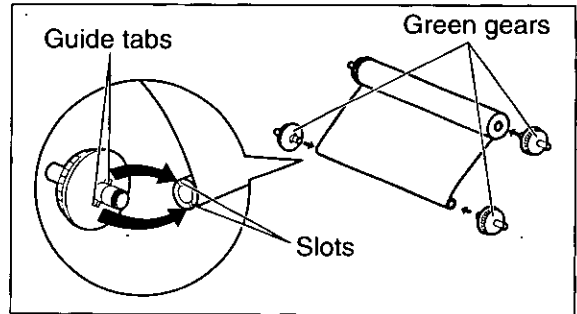

8 Insert the film into the cartridge so that the blue gear matches the blue label on the cartridge.
 • The shiny side should be facing up.

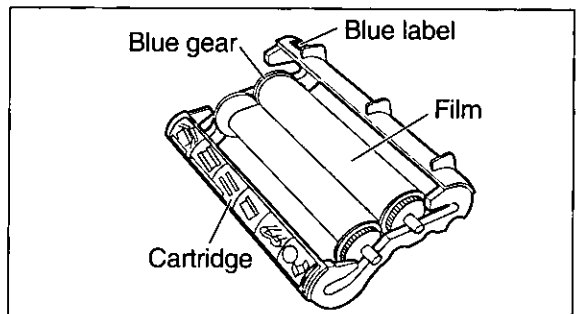

9 Lock the four gears of the film by (A) pushing back the top side gears and (B) pulling the bottom side gears forward until they lock into place.
 • If the film is slack, tighten it by winding the bottom side gears.

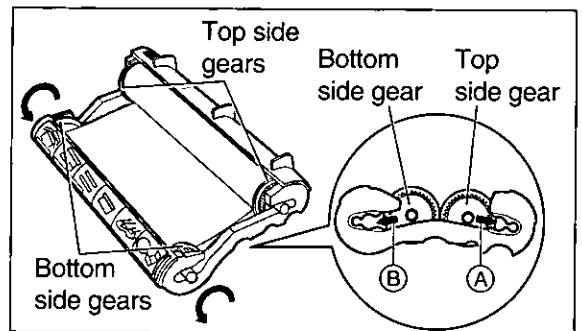
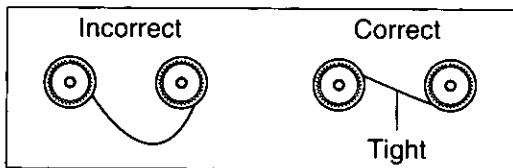

10 Insert the film cartridge by matching the blue label on the cartridge with the one on the unit.

11 Close the cover securely by pushing down on both corners.

- The unit will check if the film is installed correctly. The following message will be displayed.

Display: PLEASE WAIT

- If the following message is displayed, the film is not inserted correctly in the cartridge.

CHECK FILM

Reinsert it correctly.

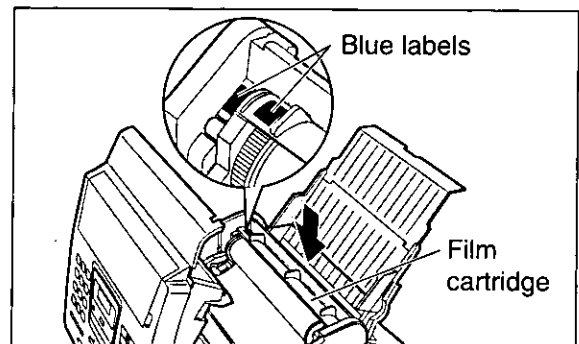

Help

Cleaning

Document feeder

If misfeeding occurs frequently or if dirty patterns or black bands appear on a copied or transmitted document, clean the document feeder.

- 1** Disconnect the power cord and the telephone line cord.
- 2** Slide the cover open lever forward.
- 3** The cover is under tension to improve print quality. Pull up hard enough to open.
- 4** Clean the document feeder rollers, sub roller and rubber flap with a cloth moistened with isopropyl rubbing alcohol, and let all parts dry thoroughly.
- 5** Clean the white plate and glass with a soft dry cloth.
- 6** Close the cover securely by pushing down on both corners.
- 7** Connect the power cord and the telephone line cord.

Caution:

- Do not use paper products, such as paper towels or tissues, to clean the inside of the unit.

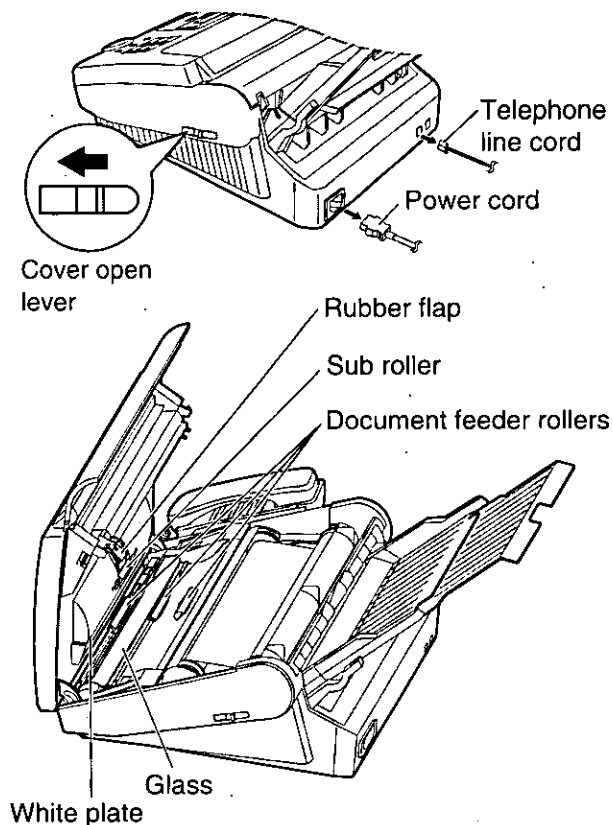

Thermal head and black bar

If dirty patterns or black or white bands appear on a copied or received document, clean the thermal head and black bar.

- 1** Disconnect the power cord and the telephone line cord.
- 2** Slide the cover open lever forward.
- 3** The cover is under tension to improve print quality. Pull up hard enough to open.
- 4** Clean the thermal head and black bar with a cloth moistened with isopropyl rubbing alcohol, and let it dry thoroughly.
- 5** Close the cover securely by pushing down on both corners.
- 6** Connect the power cord and the telephone line cord.

Caution:

- To prevent a malfunction due to static electricity, do not use a dry cloth and do not touch the thermal head directly with your fingers.

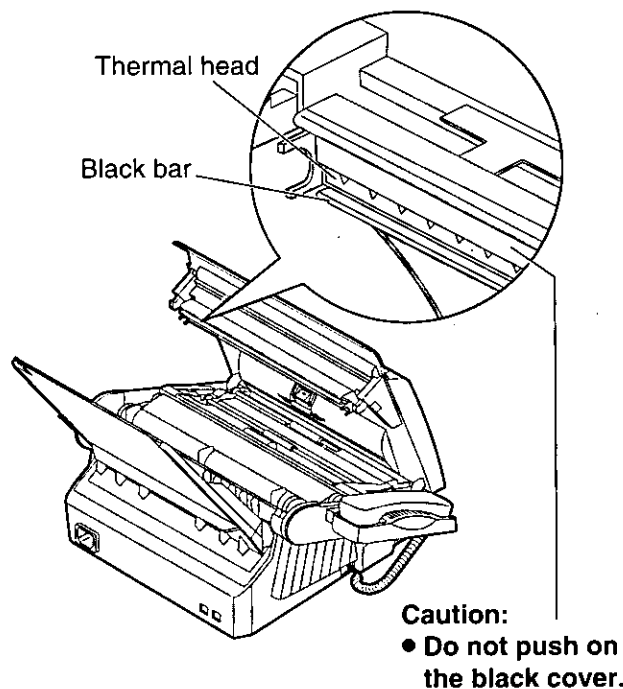

Printing the feature settings, telephone numbers, the journal and printer test list

You can print out the following documents.

Feature list: provides you with the current settings of the basic and advanced programming features (see pages 110 and 111).

Telephone number list: provides you with names and telephone numbers which are stored in One-Touch Dial and the JOG DIAL directory. The telephone number codes are as shown below.

P: A pause has been entered.

F: A flash has been entered.

[]: A secret telephone number has been entered. (The telephone number is not printed.)

Journal report: keeps records of fax transmissions and receptions. Also, this report will be printed automatically after every 35 fax communications (see page 49).

Printer test list: allows you to check the print quality of your unit. If the test print has a dirty pattern, or blurred points or lines, clean the thermal head (see page 90).

1 Press **MENU** two times.

Display: **2. PRINT REPORT**

2 For the **feature list**, press **[]**, then **1**.

SETUP LIST

For the **telephone number list**, press **[]**, then **3**.

TEL NO. LIST

For the **journal report**, press **[]**, then **4**.

JOURNAL REPORT

For the **printer test list**, press **[]**, then **5**.

PRINTER TEST

3 Press **START/COPY/SET** to start printing.

PRINTING

- To stop printing, press **STOP**.

- After printing, the following will be displayed.

PRINT ITEM []

4 Press **MENU**.

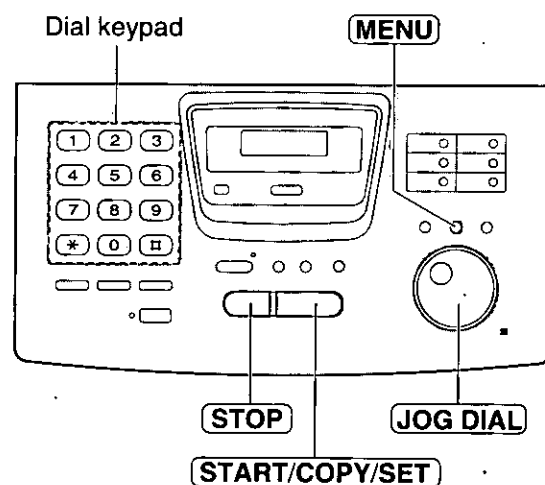

Note:

- In step 2, you can select the desired item by rotating

JOG DIAL.

Display Contrast / Reset

Changing the LCD display contrast

Use this feature to adjust the display contrast.

NORMAL: (Pre-selected setting)

DARKER: Used when the display contrast is too light.

- 1 Press **MENU**.
Display: 1.SYSTEM SET UP
- 2 Press **□**, then **3 9**.
LCD CONTRAST
- 3 Press **START/COPY/SET**.
MODE=NORMAL ▼▲
- 4 Press ▼ or ▲ to select the desired setting.
- 5 Press **START/COPY/SET**.
SETUP ITEM []
- 6 Press **MENU**.

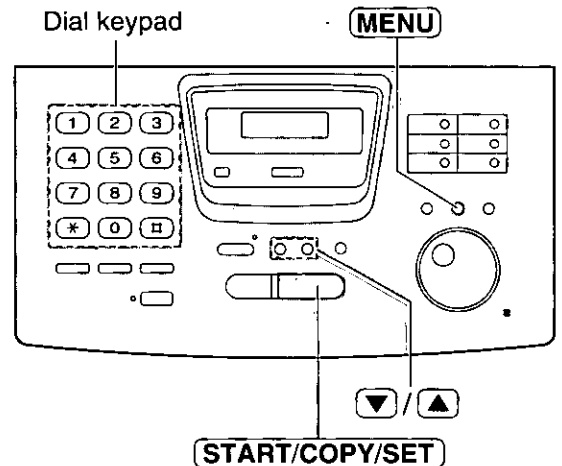

Resetting the advanced features

Use this feature to return the advanced features (see pages 110 and 111) to their pre-selected settings.

- 1 Press **MENU**.
Display: 1.SYSTEM SET UP
- 2 Press **□**, then **8 0**.
SET DEFAULT
- 3 Press **START/COPY/SET**.
RESET=NO ▼▲
- 4 Press ▼ or ▲ to select "YES".
RESET=YES ▼▲
- 5 Press **START/COPY/SET**.
RESET OK?
- If this feature is not required, press **STOP**.
- 6 Press **START/COPY/SET** again for confirmation.
RESET COMPLETED
↓
SETUP ITEM []
- 7 Press **MENU**.

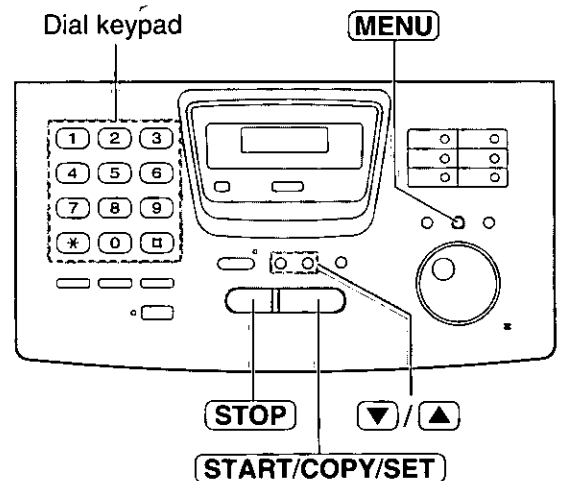

List of FCC requirements and information

If required by the telephone company, inform them of the following.

- FCC Registration No.:
(found on the bottom of the unit)
- Ringer Equivalence No.:
(found on the bottom of the unit)
- The particular telephone line to which the equipment is connected.

This unit must not be connected to a coin operated line. If you are on a party line, check with your local telephone company.

Ringer Equivalence Number (REN):

This REN is useful in determining the quantity of devices you may connect to your telephone line and still have all of those devices ring when your telephone number is called. In most but not all areas, the sum of the REN's of all devices connected to one line should not exceed five (5.0). To be certain of the number of devices you may connect to your line, as determined by the REN, you should contact your local telephone company to determine the maximum REN for your calling area.

In the event that terminal equipment causes harm to the telephone network, the telephone company should notify the customer, if possible, that service may be stopped. However, where prior notice is impractical, the company may temporarily cease service providing that they:

- a) Promptly notify the customer.
- b) Give the customer an opportunity to correct the problem with their equipment.
- c) Inform the customer of the right to bring a complaint to the Federal Communication Commission pursuant to procedures set out in FCC Rules and Regulations Subpart E of Part 68.

The Telephone Company may make changes in its communications facilities, equipment operations, or procedures where such action is reasonably required in the operation of its business and is not inconsistent with the rules and regulations in FCC Part 68. If such changes can be reasonably expected to render any customer terminal equipment incompatible with telephone company communications facilities, or require modification or

alteration of such terminal equipment, or otherwise materially affect its use or performance, the customer shall be given adequate notice in writing, to allow the customer an opportunity to maintain uninterrupted service.

CAUTION:

Any changes or modifications not expressly approved by the party responsible for compliance could void the user's authority to operate this device.

When programming emergency numbers and/or making test calls to emergency numbers:

1. Remain on the line and briefly explain to the dispatcher the reason for the call before hanging up.
2. Perform such activities in the off-peak hours; such as early morning or late evenings.

This telephone provides magnetic coupling to hearing aids.

NOTE:

This equipment has been tested and found to comply with the limits for a Class B digital device, pursuant to Part 15 of the FCC Rules. These limits are designed to provide reasonable protection against harmful interference in a residential installation. This equipment generates, uses, and can radiate radio frequency energy and, if not installed and used in accordance with the instructions, may cause harmful interference to radio communications. However, there is no guarantee that interference will not occur in a particular installation. If this equipment does cause harmful interference to radio or television reception, which can be determined by turning the equipment off and on, the user is encouraged to try to correct the interference by one or more of the following measures:

- Reorient or relocate the receiving antenna.
- Increase the separation between the equipment and receiver.
- Connect the equipment into an outlet on a circuit different from that to which the receiver is connected.
- Consult the dealer or an experienced radio/TV technician for help.

Warranty

Panasonic Consumer Electronics Company,
Division of Matsushita Electric Corporation of America
One Panasonic Way, Secaucus,
New Jersey 07094

Panasonic Sales Company
Division of Matsushita Electric of
Puerto Rico, Inc.
Ave. 65 de Infantería, Km. 9.5, San Gabriel
Industrial Park, Carolina, Puerto Rico 00985

PANASONIC Facsimile Products Limited Warranty

Panasonic Consumer Electronics Company or Panasonic Sales Company (collectively referred to as "the warrantor"), will repair this product with new or refurbished parts, free of charge, in the USA or Puerto Rico for one (1) year from the date of original purchase in the event of a defect in materials or workmanship.

This Limited Warranty Excludes both Labor and Parts for: batteries, antennas, and cosmetic parts (cabinet).

Carry-in or mail-in service in the USA or Puerto Rico can be obtained during the warranty period by contacting a Panasonic Services Company (PASC) Factory Servicenter listed in the Servicenter Directory. Or call, toll free, 1-800-HELP FAX (1-800-435-7329) to locate a PASC Factory Servicenter. Carry-in or mail-in service in Puerto Rico can be obtained during the warranty period by calling the Panasonic Sales Company telephone number listed in the Servicenter Directory.

This warranty is extended only to the original purchaser. A purchase receipt or other proof of date of original purchase will be required before warranty service is rendered.

This warranty only covers failures due to defects in material or workmanship which occur during normal use and (when applicable) does not cover the print and ink cartridge, the toner cartridge and drum unit or the film cartridge. The warranty does not cover damages which occur in shipment, or failures which are caused by products not supplied by the warrantor, or failures which result from accident, misuse, abuse, neglect, mishandling, faulty installation, misapplication, set-up adjustments, improper operation or maintenance, alteration, modification, power line surge, improper voltage supply, lightning damage, signal reception problems, commercial use such as hotel, office, restaurant, or other business or rental use of the product, or service by anyone other than a PASC Factory Servicenter or a PASC authorized Servicenter, or damage that is attributable to acts of God.

LIMITS AND EXCLUSIONS

There are no express warranties except as listed above.

THE WARRANTOR SHALL NOT BE LIABLE FOR INCIDENTAL OR CONSEQUENTIAL DAMAGES RESULTING FROM THE USE OF THIS PRODUCT, OR ARISING OUT OF ANY BREACH OF THIS WARRANTY. ALL EXPRESS AND IMPLIED WARRANTIES, INCLUDING THE WARRANTIES OF MERCHANTABILITY, ARE LIMITED TO THE APPLICABLE WARRANTY PERIOD SET FORTH ABOVE.

Some states do not allow the exclusion or limitation of incidental or consequential damages, or limitations on how long an implied warranty lasts, so the above exclusions or limitations may not apply to you.

This warranty gives you specific legal rights and you may also have other rights which vary from state to state. If a problem with this product develops during or after the warranty period, you may contact your dealer or Servicenter. If the problem is not handled to your satisfaction, then write to the Customer Satisfaction Center at the company address indicated above.

Servicenter Directory

For Product Information, Operating Assistance, Literature Request, Dealer Locations, and all Customer Service inquiries please contact:
1-800-HELP-FAX (435-7329), Monday-Friday 9am - 8pm EST.

Web Site: <http://www.Panasonic.com>
 You can purchase parts, accessories or locate your nearest servicenter by visiting our Web Site.

Factory Servicenters Locations

<p>CALIFORNIA 6550 Katella Avenue Cypress, CA 90630</p> <p>800 Dubuque Avenue S. San Francisco, CA 94080</p> <p>20201 Sherman Way Suite 102 Canoga Park, CA 91306</p> <p>3878 Ruffin Road Suite A San Diego, CA 92123</p> <p>COLORADO 1640 South Abilene Street Suite D Aurora, CO 80012</p> <p>FLORIDA 3700 North 29th Avenue Suite 102 Hollywood, FL 33020</p>	<p>GEORGIA 8655 Roswell Road Suite 100 Atlanta, GA 30350</p> <p>ILLINOIS 9060 Golf Road Niles, IL 60714</p> <p>1703 North Randall Road Elgin, IL 60123 (Pick-up / Drop-off only)</p> <p>MARYLAND 62 Mountain Road Glen Burnie, MD 21061</p> <p>MASSACHUSETTS 60 Glacier Drive Suite G Westwood, MA 02090</p>	<p>MICHIGAN 37048 Van Dyke Avenue Sterling Heights, MI 48312</p> <p>MINNESOTA 7850-12th Avenue South Airport Business Center Bloomington, MN 55425</p> <p>OHIO 2236 Waycross Road Civic Center Plaza Forest Park, OH 45240</p> <p>PENNSYLVANIA 2221 Cabot Blvd. West Suite B Langhorne, PA 19047</p> <p>Chartiers Valley Shopping Center 1025 Washington Pike Bridgeville, PA 15017</p>	<p>TENNESSEE 3800 Ezell Road Suite 806 Nashville, TN 37211</p> <p>TEXAS 7482 Harwin Drive Houston, TX 77036</p> <p>13615 Welch Road Suite #101 Farmers Branch, TX 75244</p> <p>WASHINGTON 20425-84th Avenue South Kent, WA 98032</p> <p>HAWAII 99-859 Iwaiwa Street Aiea, Hawaii 96701 Phone (808) 488-1996 Fax (808) 486-4369</p>
--	--	---	---

Service in Puerto Rico

Matsushita Electric of Puerto Rico, Inc. Panasonic Sales Company/ Factory Servicenter:
 Ave. 65 de Infantería, Km. 9.5, San Gabriel Industrial Park, Carolina, Puerto Rico 00985
 Phone (787) 750-4300 Fax (787) 768-2910

Accessory Purchases:

Customer Orders Only 1-800-HELP-FAX (435-7329)

Warranty

Notes for product service and shipping the product --- ---

For product service

- Servicenters are listed on page 95.
- Call toll free 1-800-HELP-FAX (435-7329) for the location of an authorized servicenter.

When you ship the product

- Carefully pack your unit, preferably in the original carton.
- Attach a letter, detailing the symptom or problem, to the outside of the carton.
- Send the unit to an authorized servicenter, prepaid and adequately insured.
- Do not send your unit to the Panasonic Consumer Electronics Company or to any executive or regional sales offices. These locations do not repair consumer products.

Technical data about this product

Applicable Lines:	Public Switched Telephone Network
Document Size:	Max. 216 mm (8½") in width Max. 600 mm (23⅝") in length
Effective Scanning Width:	208 mm (8⅜")
Recording Paper Size:	Letter: 216 mm × 279 mm (8½"×11") Legal: 216 mm × 356 mm (8½"×14")
Effective Printing Width:	208 mm (8⅜")
Transmission Time*:	Approx. 15 s/page (Original mode) Approx. 30 s/page (G3 Normal mode)
Scanning Density:	Horizontal: 8 pels/mm (203 pels/inch) Vertical: 3.85 lines/mm (98 lines/inch) —STANDARD mode 7.7 lines/mm (196 lines/inch) —FINE/HALF TONE mode 15.4 lines/mm (392 lines/inch) —SUPER FINE mode
Halftone Level:	64-level
Scanner Type:	CCD image sensor
Printer Type:	Thermal Printing
Data Compression System:	Modified Huffman (MH), Modified READ (MR)
Modem Speed:	9,600 / 7,200 / 4,800 / 2,400 bps; Automatic Fallback
Operating Environment:	5 °C – 35 °C (41 °F – 95 °F), 20 % – 80 % RH (Relative Humidity)
Dimensions (H×W×D):	154 mm × 365 mm × 355 mm (6⅛" × 14⅜" × 13⅜")
Mass (Weight):	Approx. 4.85 kg (10.7 lb.)
Power Consumption:	Standby: Approx. 4.0 W Transmission: Approx. 13 W Reception: Approx. 37 W (When receiving a 20% black document) Copy: Approx. 48 W (When copying a 20% black document) Maximum: Approx. 160 W (When using a 100% black document)
Power Supply:	120 V AC, 60 Hz (This unit will not function at 50 Hz.)
Memory Capacity:	Approx. 28 pages memory reception Approx. 25 pages memory transmission (Based on CCITT No. 1 Test Chart in standard resolution)

*Transmission speed depends upon the contents of the pages, resolution, telephone line conditions and capability of the receiving unit.
The 15 second speed is based upon CCITT No.1 Test Chart.

CCITT No.1 Test Chart

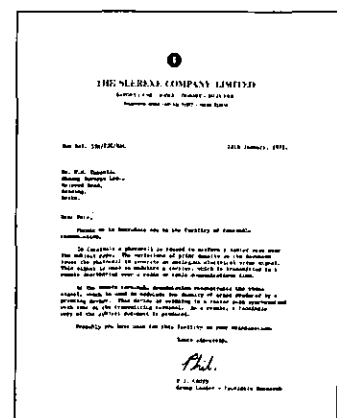

General Information

- Note:**
- Any details given in these instructions are subject to change without notice.
 - The pictures and illustrations in these instructions may vary slightly from the actual product.

Comienzo rápido en español

- Esta guía le ofrece una explicación básica en español sobre cómo utilizar su facsímil.

Índice	Página
Instalación	99
Conexiones	100
Programación inicial	101
Memorización de nombres y números de teléfono para la marcación de un toque.....	102
Memorización de nombres y números de teléfono en el directorio JOG DIAL.....	103
Para hacer/contestar una llamada de voz.....	104
Envío de un fax.....	105
Reciviendo un fax.....	106
Para hacer una copia	107

Instalación

Quite la cinta de transporte de la unidad y del apilador y haga la instalación de la forma siguiente.

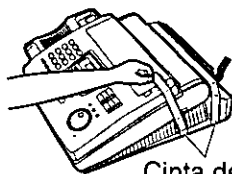

Cinta de transporte

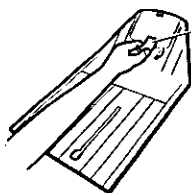

Cinta de transporte

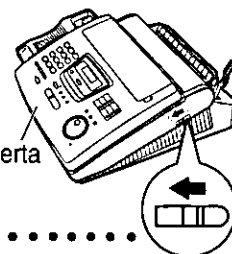

Cubierta

Palanca de apertura de la cubierta

1 Cartucho de película

- A. Deslice hacia adelante la palanca de apertura de la cubierta.
- B. La cubierta está bajo tensión para mejorar la calidad de la impresión. Tire hacia arriba con fuerza suficiente para abrirla.
- C. Quite la hoja de la unidad.
- D. Si la película está floja en su cartucho, ténsela girando los engranajes del lado inferior.

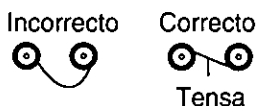

Incorrecto

Correcto

Tensa

- E. Instale el cartucho de película en el interior de la unidad.
- F. Asegúrese de que la etiqueta azul del cartucho concuerde con la de la unidad.
- G. Cierre firmemente la cubierta empujando hacia abajo sobre ambas esquinas.

3 Bandeja de papel

- A. Abra la bandeja de papel.
- B. Inserte las dos lengüetas de la bandeja de papel en las ranuras de la parte trasera de la unidad.

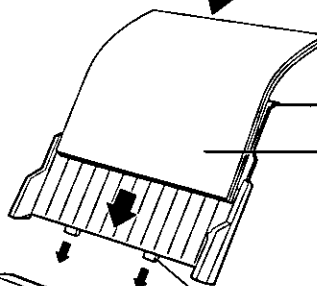

Lengüeta
Palanca de ajuste del papel de impresión

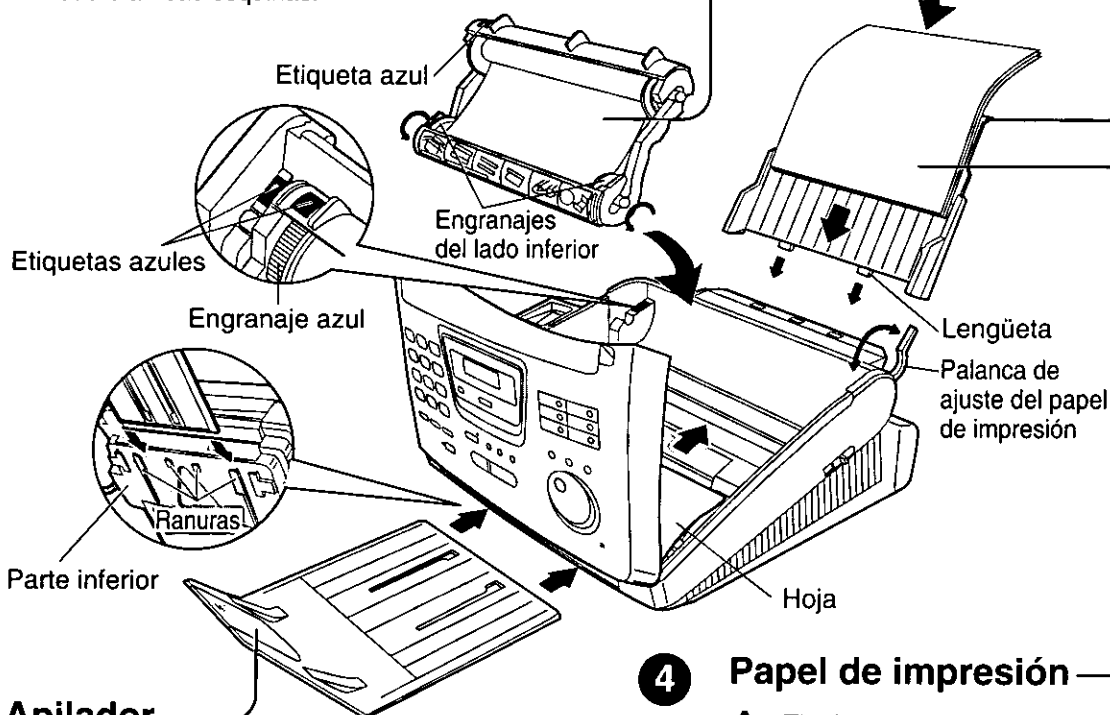

Etiqueta azul

Engranajes del lado inferior

Etiquetas azules

Engranaje azul

Ranuras

Parte inferior

Hoja

2 Apilador

- A. Levante la parte delantera de la unidad, inserte el apilador en las ranuras y deslícelo hasta que se pare.

4 Papel de impresión

- A. Tire hacia adelante de la palanca de ajuste del papel de impresión.
- B. Separe el papel para evitar que se atasque e insértelo en el interior de la bandeja de papel.
- C. Mueva hacia atrás la palanca de ajuste del papel de impresión.

Comienzo rápido en español

Conexiones

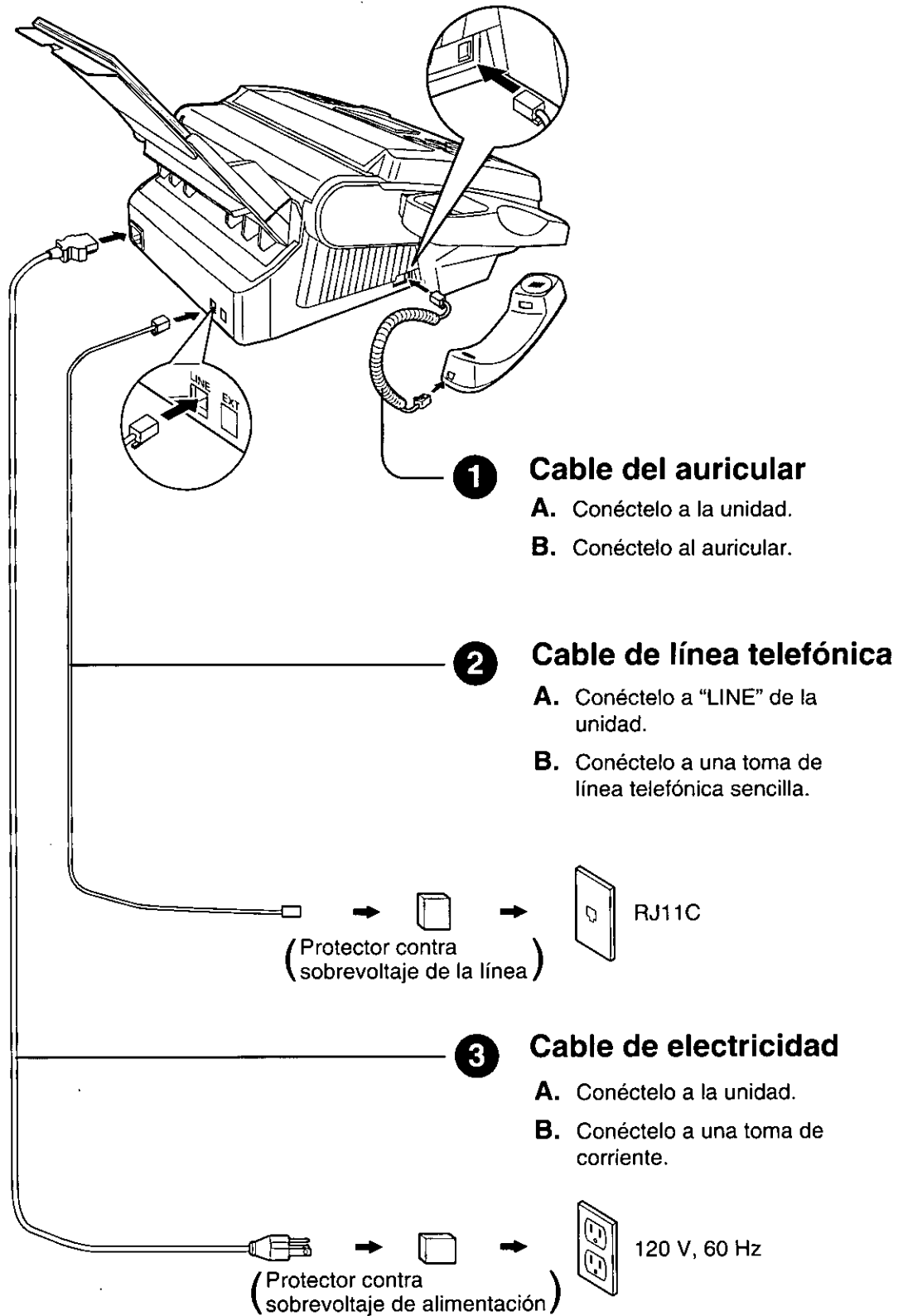

Programación inicial

Ajuste de la fecha y la hora

- 1 Pulse **MENU**.
- 2 Pulse **[]**, y luego **0 1**.
- 3 Pulse **START/COPY/SET**.
- 4 Introduzca el mes/día/año correcto seleccionándolos con 2 dígitos para cada uno utilizando el teclado de marcación o **JOG DIAL**. Si utiliza **JOG DIAL**, pulse **[▶]** para mover el cursor.
- 5 Pulse **START/COPY/SET**.
- 6 Introduzca la hora/minuto correcto seleccionando cada uno de ellos mediante 2 dígitos con el teclado de marcación o **JOG DIAL**. Si utiliza **JOG DIAL**, pulse **[▶]** para mover el cursor.
Pulse **[*]** para seleccionar "AM" o "PM".
- 7 Pulse **START/COPY/SET**.
- 8 Pulse **MENU**.

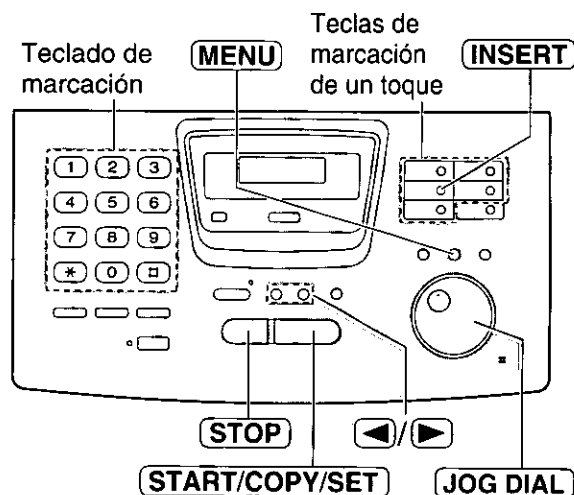

Ajuste de su logotipo

- 1 Pulse **MENU**.
- 2 Pulse **[]**, y luego **0 2**.
- 3 Pulse **START/COPY/SET**.
- 4 Introduzca su logotipo, con un máximo de 30 caracteres, utilizando el teclado de marcación (consulte las instrucciones de la derecha) o **JOG DIAL** (consulte la página siguiente).
 - Para introducir continuamente el mismo número, pulse **[▶]** para mover el cursor al siguiente espacio.
- 5 Pulse **START/COPY/SET**.
- 6 Pulse **MENU**.

Selección de caracteres con el teclado de marcación

Teclas		Caracteres
Teclas de marcación	1	1 [] { } + - / = , . _ ' : ; ?
	2	A B C a b c 2
	3	D E F d e f 3
	4	G H I g h i 4
	5	J K L j k l 5
	6	M N O m n o 6
	7	P Q R S p q r s 7
	8	T U V t u v 8
	9	W X Y Z w x y z 9
	0	0 () < > ! " # \$ % & ¥ * @ ^ ' →
Teclado de marcación de un toque	Tecla INSERT (Se utiliza para insertar un carácter o un espacio.)	

Ajuste del número de teléfono de su facsímil

- 1 Pulse **MENU**.
- 2 Pulse **[]**, y luego **0 3**.
- 3 Pulse **START/COPY/SET**.
- 4 Introduzca el número de teléfono de su facsímil con un máximo de 20 dígitos utilizando el teclado de marcación o **JOG DIAL**. Si utiliza **JOG DIAL**, pulse **[▶]** para mover el cursor.
 - El botón **[]** reemplaza un carácter por un espacio y el botón **[*]** reemplaza un carácter por un signo "+".
- 5 Pulse **START/COPY/SET**.
- 6 Pulse **MENU**.

Para corregir un error

- Pulse **[◀]** o **[▶]** para mover el cursor al carácter incorrecto, y luego haga la corrección.
- Para borrar un carácter, mueva el cursor al carácter que desee borrar y pulse **STOP** para las características número #02 y #03.

Comienzo rápido en español

Memorización de nombres y números de teléfono para la marcación de un toque

- 1 Pulse **DIRECTORY PROGRAM**.
- 2 Para las estaciones 1-5
Pulse una de las teclas de marcación de un toque.
 - Si selecciona la tecla de marcación de un toque 1, seleccione "DIAL MODE" pulsando **▼**, y luego pulse **START/COPY/SET** para ir a la siguiente indicación.

Para las estaciones 6-10
Pulse **LOWER**, y luego pulse una de las teclas de marcación de un toque.
- 3 Introduzca el nombre de la estación, un máximo de 10 caracteres, utilizando el teclado de marcación (consulte la página 101) o **JOG DIAL** (consulte abajo).
- 4 Pulse **START/COPY/SET**.
- 5 Introduzca el número de teléfono, un máximo de 30 dígitos.
- 6 Pulse **START/COPY/SET**.
- 7 Pulse **STOP** para salir de la programación.

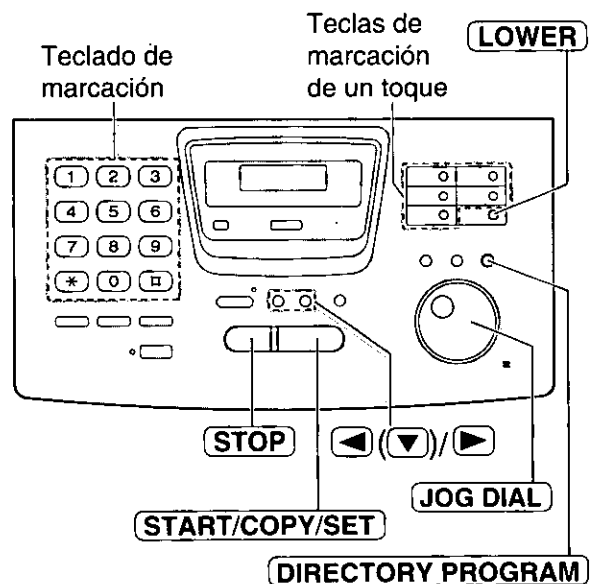

Selección de caracteres con JOG DIAL

En lugar de pulsar las teclas de marcación podrá seleccionar caracteres utilizando JOG DIAL.

1. Gire **JOG DIAL** hasta que se visualice el carácter deseado.
2. Pulse **▶** para mover el cursor al siguiente espacio.
 - Se inserta el carácter visualizado en el paso 1.
3. Vuelva al paso 1 para introducir el siguiente carácter.

Orden de visualización de los caracteres

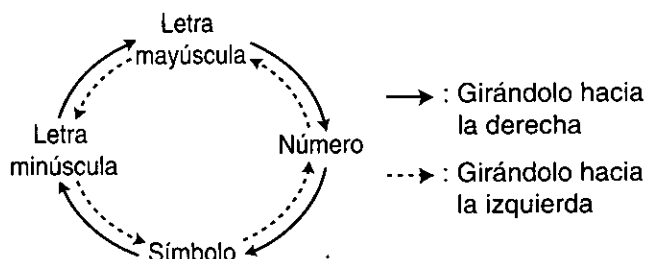

Memorización de nombres y números de teléfono en el directorio JOG DIAL

Para acceder rápidamente a los números marcados frecuentemente, además de la marcación de un toque, la unidad proporciona también el directorio JOG DIAL (100 estaciones para el KX-FP250, 60 estaciones para el KX-FP245).

- 1 Pulse **DIRECTORY PROGRAM**.
- 2 Gire **JOG DIAL** e introduzca el nombre, hasta 10 caracteres, utilizando el teclado de marcación (consulte la página 101) o **JOG DIAL** (consulte la página 102).
- 3 Pulse **START/COPY/SET**.
- 4 Introduzca el número de teléfono, un máximo de 30 dígitos.
- 5 Pulse **START/COPY/SET**.
- 6 Pulse **STOP** para salir de la programación.



Para corregir un error

- Pulse ◀ o ▶ para mover el cursor al carácter incorrecto, y luego haga la corrección.

Para borrar un carácter

- Mueva el cursor al carácter que desee borrar y pulse **STOP**.

Comienzo rápido en español

Para hacer/contestar una llamada de voz

■ Para hacer manualmente una llamada de voz

- 1 Levante el auricular.
- 2 Marque el número.
- 3 Cuelgue el auricular cuando termine.

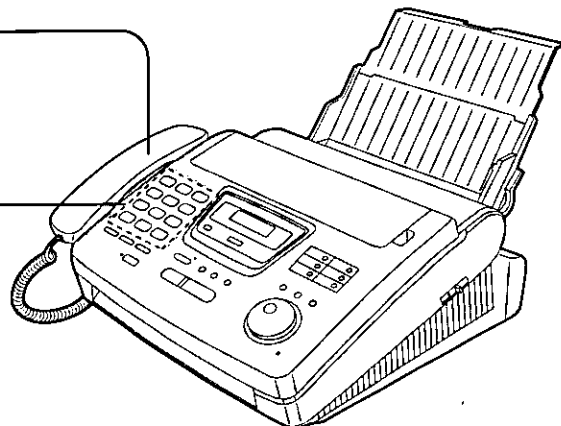

■ Para hacer una llamada de voz utilizando la marcación de un toque

- 1 Levante el auricular.
- 2 **Para las estaciones 1-5**
Pulse la tecla de marcación de un toque deseada.
Para las estaciones 6-10
Pulse (**LOWER**), y luego pulse la tecla de marcación de un toque deseada.
- 3 Cuelgue el auricular cuando termine.

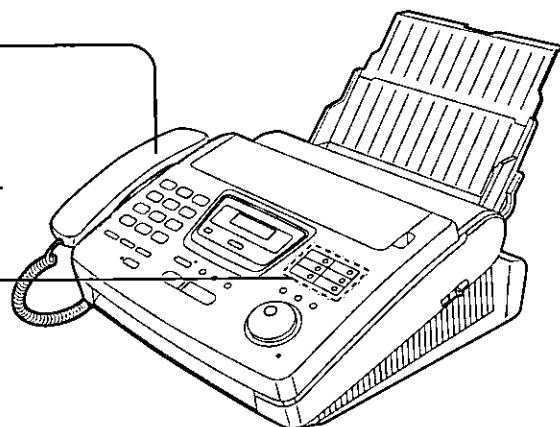

■ Para hacer una llamada de voz utilizando el directorio JOG DIAL

- 1 Gire (**JOG DIAL**) hasta que se visualice el nombre deseado.
- 2 Levante el auricular.
 - La unidad empezará a marcar automáticamente.
- 3 Cuelgue el auricular cuando termine.

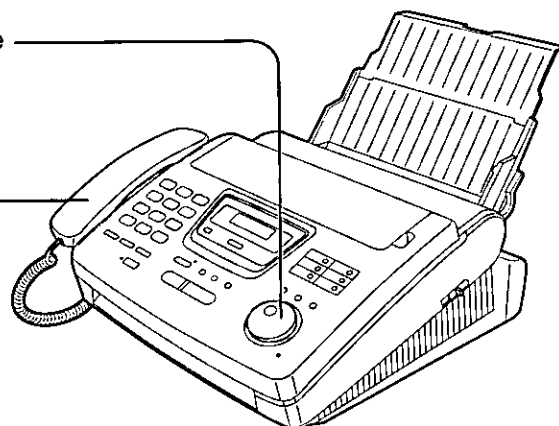

■ Para contestar una llamada de voz

- 1 Levante el auricular cuando oiga el timbre de la unidad.
- 2 Cuelgue el auricular cuando termine.

Envío de un fax

■ Envío manual de un fax

- 1 Abra la bandeja del alimentador de documentos.
- 2 Ajuste la anchura de las guías de documentos según el tamaño del documento.
- 3 Inserte el documento hasta que se oiga un pitido.
- 4 Pulse **SP-PHONE**.
- 5 Marque el número del fax.
- 6 Pulse **START/COPY/SET** cuando oiga el tono del fax.

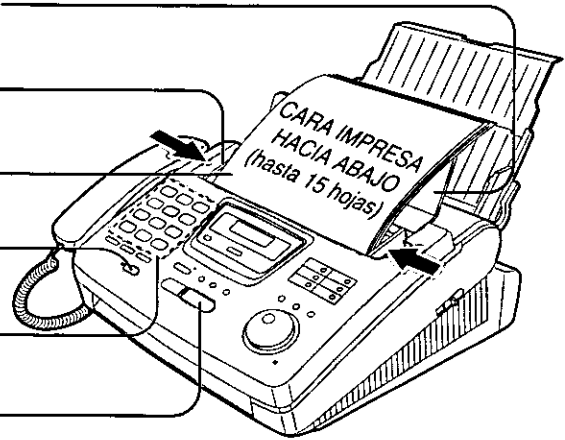

■ Envío de un fax utilizando la marcación de un toque

- 1 Abra la bandeja del alimentador de documentos.
- 2 Ajuste la anchura de las guías de documentos según el tamaño del documento.
- 3 Inserte el documento hasta que se oiga un pitido.
- 4 **Para las estaciones 1-5**
Pulse la tecla de marcación de un toque deseada.
Para las estaciones 6-10
Pulse **LOWER**, y luego pulse la tecla de marcación de un toque deseada.

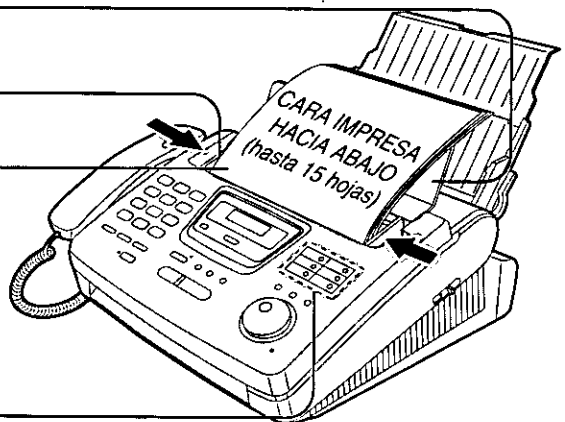

■ Envío de un fax utilizando el directorio JOG DIAL

- 1 Abra la bandeja del alimentador de documentos.
- 2 Ajuste la anchura de las guías de documentos según el tamaño del documento.
- 3 Inserte el documento hasta que se oiga un pitido.
- 4 Gire **JOG DIAL** hasta que se visualice el nombre deseado.
- 5 Pulse **START/COPY/SET**.

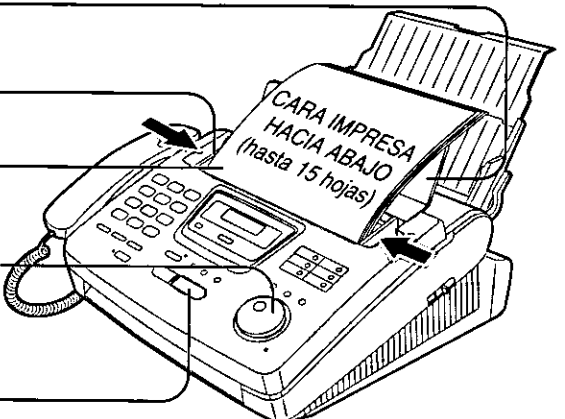

Comienzo rápido en español

Reciviendo un fax

■ Recepción manual de un fax

- 1 Levante el auricular cuando oiga el timbre de la unidad.
- 2 Cuando:
 - sea necesario recibir un documento,
 - se oiga un tono de llamada de fax (pitido lento), o
 - no se oiga sonido,pulse **START/COPY/SET**.
- 3 Cuelgue el auricular.

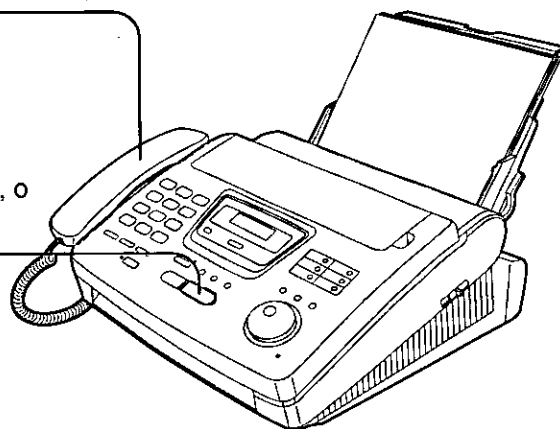

■ Recepción automática de un fax,

- 1 Ponga la unidad en el modo AUTO ANSWER pulsando **AUTO ANSWER** hasta que se encienda el indicador AUTO ANSWER.

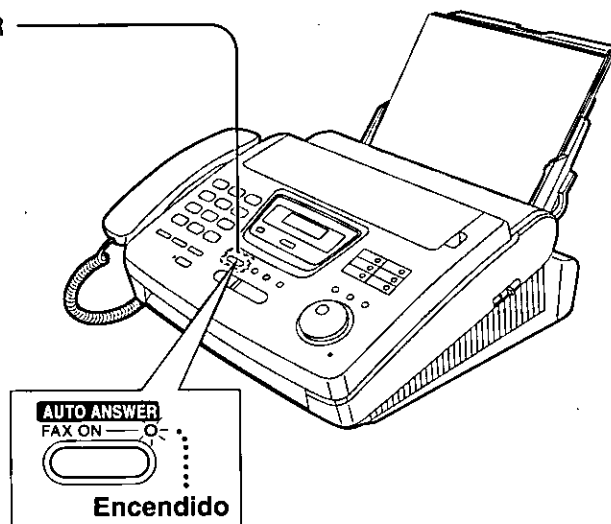

Para hacer una copia

- 1 Abra la bandeja del alimentador de documentos.
- 2 Ajuste la anchura de las guías de documentos según el tamaño del documento.
- 3 Inserte el documento hasta que se oiga un pitido.
- 4 Pulse **START/COPY/SET**.
- 5 Introduzca el número de copias (hasta 99).
- 6 Pulse **START/COPY/SET**.

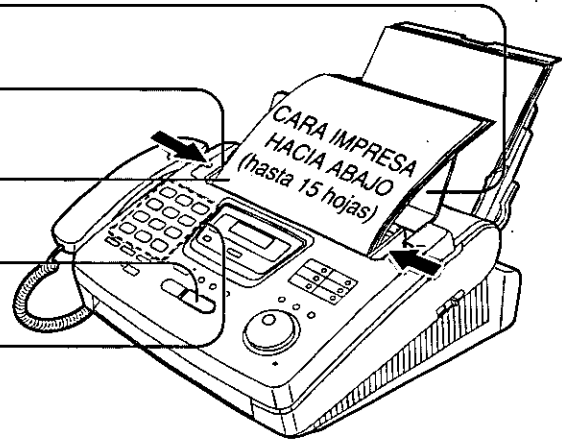

Index

Index

- A** Accessories 14
- Advanced features 110, 111
 - (Resetting) 92
- Answering machine 61, 62, 63
- AUTO ANSWER button 56, 59, 68
- AUTO ANSWER mode 56, 59, 68
- Automatic dialing mode setting 24

- B** Basic features 110
- BROADCAST key 52, 53
- Broadcast report 53

- C** Character table 27, 35
- Cleaning 90
- COLLATE button 76
- Communication messages 78
- Connecting tone 55
- Connections 6, 24
- Copy (Collated) 76, 77
 - (Enlargement/reduction) 76, 77
 - (Multiple copies) 76
- COPY button 11, 76

- D** Date and time 25
- Delayed transmission 50
- Dialing mode 33
- Directory feature 37, 39, 43
- DIRECTORY
 - PROGRAM button 34, 37, 38, 52
- Display contrast 92
- Distinctive Ring service 64, 65
- Document feeder cleaning 90
- Document jam 87
- Document size 47, 97

- E** Enlarge/Reduce copy 76, 77
- Error messages 78, 79, 80
- Extension telephone 67, 70

- F** Facsimile telephone number 28
- Fax activation code 70
- Fax auto redial 42
- FAX ONLY mode 56, 59, 60
- FAX ONLY ring count 60
- Fax pager 74
- Feature list 91
- Feeder cleaning 90
- Feeder jam 87
- Feeder pressure 87
- Film detection 75
- Film/Film cartridge (Installing) 4, 19, 20
 - (Replacing) 88, 89
- FILM REMAINING button 88
- FLASH button 32
- Friendly reception 58, 73

- H** Handset cord 6, 24
- Handset receiver volume 29
- HELP button 15
- HYPHEN key 27, 34, 35

- I** Ink film 88, 89
- INSERT key 26, 27, 35
- IQ-FAX 44, 45, 46
- IQ-FAX button 46

- J** Jam 85, 86, 87
- JOG DIAL (Making a voice call) 39
 - (Selecting characters) .. 27, 35
 - (Sending faxes) 43
 - (Storing) 37, 38
- Journal auto print 49
- Journal report 49, 91

- L** LCD contrast 92
- LCD display (Error messages) 79, 80
- Legal paper 21
- List (Feature) 91
 - (Printer test) 91
 - (Telephone number) 91
- Location panel 16, 17
- Logo 26, 27
- LOWER key 34, 36, 42

- M** Memory reception alert 58, 73
- Memory transmission 51
- MUTE button 30

- N** NAME/TEL NO. key 39

- O** One-Touch Dial (Making a voice call) ... 36
 - (Sending faxes) 42
 - (Storing) 34, 35
- Other size documents 71
- Overseas transmission mode 54
- Overview 18

- P** Pager call 74
- Paper jam 85, 86
- Paper tray 5, 22
- PAUSE button 32
- Power down report 84
- Power failure 84
- Power supply/cord 6, 24, 97
- Printing paper size 97
- Printing reports 91
- Problem solving 81, 82, 83, 84
- Programmable features 110, 111
- Pulse 33

- R** Receiving (Fax) 10, 58
 (Setting) 56, 57
 Receiving reduction 71
 Recording paper 5, 22, 23, 97
 Recording paper jam 85, 86
 REDIAL button 30, 41
 Remote activation ID 63
 Report (Broadcast) 53
 (Feature setting) 91
 (Journal) 49, 91
 (Printer test list) 91
 (Sending) 48
 (Telephone numbers) 91
 Reset 92
 RESOLUTION button 41, 42, 43, 46, 76
 Ring count 60, 69
 Ring pattern detection 64, 65
 Ringer volume 29
- S** SECRET key 34, 35, 37
 Sending (From memory) 51
 (IQ-FAX) 44, 45, 46
 (JOG DIAL) 43
 (Manually) 9, 41
 (Multiple stations) 52, 53
 (One-Touch Dial) 42
 Sending documents (Does not feed or
 multi-feeds) 87
 Sending jam 87
 Sending report 48
 Set default 92
 Silent detection 72
 Silent fax recognition ring 69
 SP-PHONE button 30, 31, 40
 Speaker volume 29
 Specifications 97
 Stacker 5, 21
 Storing (JOG DIAL) 37, 38
 (One-Touch Dial) 34, 35
- T** TEL mode 56, 58
 TEL/FAX delayed ring count 69
 TEL/FAX mode 66, 67, 68, 69
 Telephone line cord 6, 24
 Telephone number list 91
 Thermal head cleaning 90
 TONE button 32
 Transmission (IQ-FAX) 44, 45, 46
 (JOG DIAL) 43
 (Manually) 9, 41
 (One-Touch Dial) 42
 Transmittable document 47, 97
- V** Voice call (Answering) 8, 31
 (JOG DIAL) 39
 (Making) 7, 30
 (One-Touch Dial) 36
 Voice contact 40
 VOLUME button 29
- Z** ZOOM button 76, 77

Features Summary

Summary of user programmable features

Basic features

Code	Feature & Display	Available settings	Meaning	Page
#01	Setting the date and time SET DATE & TIME	(2 digits for each entry)	mm/dd/yy hh:mm	25
#02	Setting your logo YOUR LOGO	(Up to 30 characters)		26
#03	Setting your facsimile telephone number YOUR FAX NO.	(Up to 20 digits)		28
#04	Printing the sending report SENDING REPORT	ERROR ON OFF	If transmission fails Activate Deactivate	48
#07	Setting the FAX ONLY mode ring count FAX RING COUNT	1, 2, 3, 4, 5 EXT.TAM	1 to 5 rings (5 rings for use with an answering machine)	60
#12	Securing the remote operation for the answering machine REMOTE TAM ACT.	ON / ID=11 OFF	Activate Deactivate	63
#13	Setting the dialing mode DIALING MODE	AUTO TONE PULSE	Sets the dialing mode automatically Sets to TONE Sets to PULSE	33
#15	Setting the memory transmission SEND BY MEMORY	ON OFF	Activate Deactivate	51

(The pre-selected is in bold.)

Note:

- You can display the basic features in the order above by rotating **JOG DIAL** instead of entering the code number (#01, #02, etc.).

Advanced features

Code	Feature & Display	Available settings	Meaning	Page
#22	Setting the journal report to print automatically AUTO JOURNAL	ON OFF	Activate Deactivate	49
#23	Sending documents overseas OVERSEAS MODE	ON OFF	Activate Deactivate	54
#25	Sending a fax at a specific time DELAYED SEND	ON OFF	Activate Deactivate	50
#30	Setting the silent fax recognition ring count SILENT FAX RING	3, 4, 5, 6	3 to 6 rings	69

Features Summary

Advanced features

Code	Feature & Display	Available settings	Meaning	Page
#31	Setting the Distinctive Ring pattern RING DETECTION	A, B, C, D	Patterns A-D	65
		OFF	Deactivate	
#36	Receiving other sizes of documents RCV REDUCTION	100%	Deactivate reduction	71
		92%	92% reduction	
		86%	86% reduction	
		72%	72% reduction	
#39	Changing the LCD display contrast LCD CONTRAST	NORMAL	Normal contrast	92
		DARKER	Darker contrast	
#40	Setting the silent detection SILENT DETECT.	ON	Activate	72
		OFF	Deactivate	
#41	Changing the fax activation code FAX ACTIVATION	ON / CODE= * 9	Activate	70
		OFF	Deactivate	
#44	Setting the memory reception alert RECEIVE ALERT	ON	Activate	73
		OFF	Deactivate	
#46	Setting the friendly reception FRIENDLY RCV	ON	Activate	73
		OFF	Deactivate	
#70	Signaling your pager when your unit receives a fax FAX PAGER CALL	ON	Activate	74
		OFF	Deactivate	
#75	Setting the IQ-FAX function IQ-FAX	ON	Activate	45
		OFF	Deactivate	
#76	Setting the connecting tone CONNECTING TONE	ON	Activate	55
		OFF	Deactivate	
#77	Changing the AUTO ANSWER setting AUTO ANSWER	FAX ONLY	Facsimile only mode	68
		TEL/FAX	Telephone/Facsimile mode	
#78	Setting the TEL/FAX delayed ring count TEL/FAX RING	1, 2, 3, 4	1 to 4 rings	69
#79	Setting the film detection FILM DETECTION	ON	Activate	75
		OFF	Deactivate	
#80	Resetting the advanced features SET DEFAULT	YES	Reset	92
		NO	Will not reset	

(The pre-selected is in bold.)

Panasonic FAX ADVANTAGE PROGRAM

**Free peace of mind,
direct from Panasonic**

NO EXTRA COST



- **1-year limited warranty¹ parts & labor**
- **Toll-free help line**
- **Free overnight replacement² and repair program**

The Panasonic Fax Advantage Consumer Service Program.

Panasonic knows that if your fax machine is not up and running, neither is your business. That's why we created the Panasonic Fax Advantage Program. Included at no extra cost with the purchase of a Panasonic Fax Machine, the Fax Advantage Program can provide a free replacement unit² overnight if your original unit is in need of repair.

Here's how it works:

1. If you have a problem with your fax while it is covered by the one-year limited warranty¹, call our toll-free help-line at 1-800-HELPFAX.
2. Talk to one of our technical experts to diagnose your problem over the phone.
3. If repairs are necessary and you are entitled to service under the terms and conditions of the limited warranty³, we will send a refurbished replacement unit to you overnight or second business day delivery, depending on the time of your call.

A second option available under our one-year limited warranty is to mail-in or carry-in your fax to one of our Regional Service centers, where the unit will be repaired and returned to you.

Instructions

If you choose to receive a replacement unit under the Fax Advantage Program, Panasonic will provide a replacement unit which will be completely refurbished, quality-tested by Panasonic technicians and individually hand-inspected before it is shipped to you. You will keep the replacement unit and send the original unit to us in the replacement unit's box. UPS will pick up the unit at no charge to you, should it be determined that you are entitled to warranty service. A proof-of-purchase must be included with the returned product. Any unit that is replaced by Panasonic and not shipped with proper proof-of-purchase by you will be subject to a minimum \$100.00 charge. The original unit must be properly packaged in the same manner as the replacement unit, utilizing

the packing materials provided. Damage due to improper or inadequate packing will be charged to you as an out-of-warranty cost.

If our 1-800-HELPFAX technicians determine that your unit may be an "out-of-box failure", we will attempt to provide you with a factory-new replacement unit⁴. You must ship a copy of your receipt with your original unit to verify that you purchased the unit within 10 days prior to your 1-800-HELPFAX call.

Requirements

You must give our technicians a valid credit card number (Discover, VISA, Master Card, or American Express/Optima). Product that is not returned to Panasonic by 10 business days after shipment of the replacement product will be charged to your credit card account at Panasonic's Suggested Retail Price (see dealer for details). If your original unit is not eligible for warranty service, your card will be charged for the non-warranty repair of the unit at Panasonic's current rate for parts and labor and for any shipping charges associated with this program. If you do not wish to pay out-of-warranty repair costs, you will be responsible for returning the replacement unit to Panasonic and for paying all shipping charges associated with this program including the overnight delivery of the replacement product to you, shipment of the problem unit to Panasonic, shipment of the replacement unit back to Panasonic and the return of your original unit back to you. Credit status will be verified prior to sending the replacement product.

1. See dealer for limited warranty details.
2. Replacement unit is refurbished.
3. Replacement program excludes Puerto Rico and is subject to termination at any time without advance notice.
4. "Out-of-box failure" is an inoperable unit that was purchased no more than 10 days prior to your 1-800-HELPFAX call, and would otherwise qualify for warranty service under the terms and conditions of the limited warranty.
5. Panasonic reserves the right to send a refurbished unit.

**Panasonic Consumer Electronics
Company, Division of Matsushita
Electric Corporation of America**
One Panasonic Way, Secaucus,
New Jersey 07094

**Panasonic Sales Company,
Division of Matsushita Electric
of Puerto Rico, Inc. ("PSC")**
Ave. 05 de Infantería, Km. 9.5
San Gabriel Industrial Park, Carolina,
Puerto Rico 00985